

Partridge

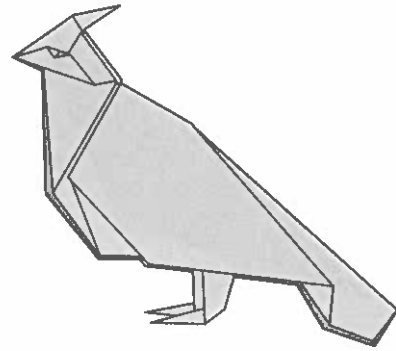

On the first day of Christmas,
my true love sent to me
A partridge in a pear tree.

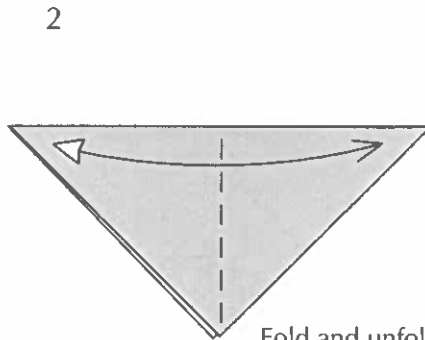
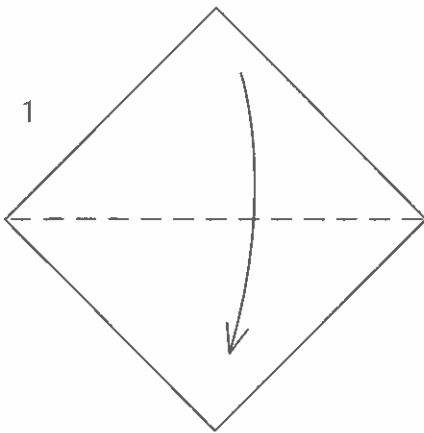

Fold and unfold.

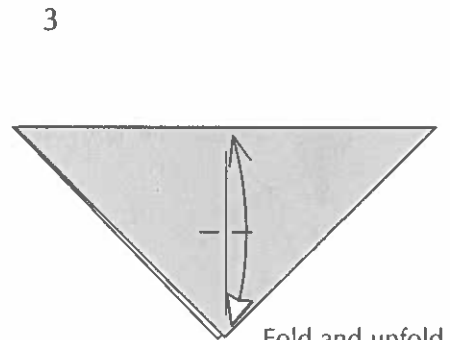

Fold and unfold
one layer.

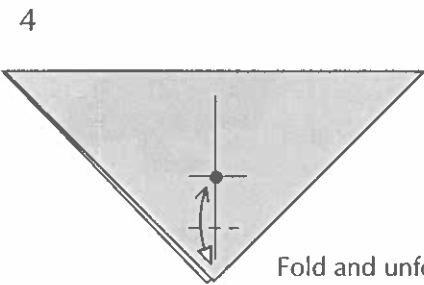

Fold and unfold
one layer.

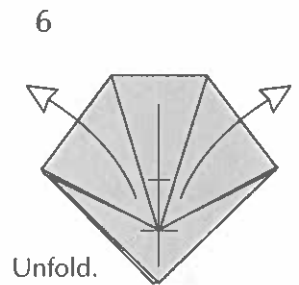
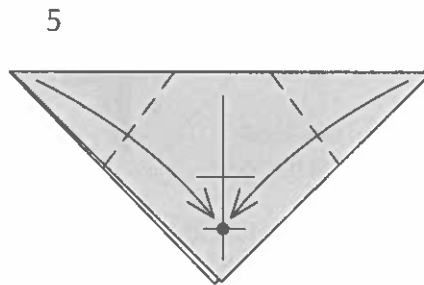

Unfold.

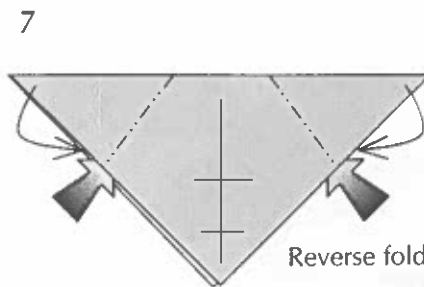

Reverse folds.

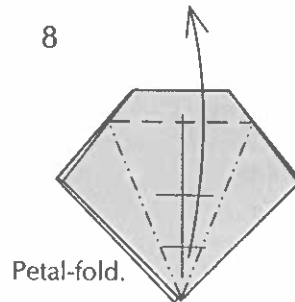

Petal-fold.

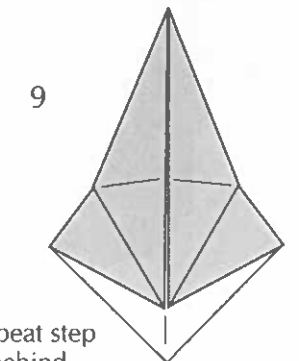

Repeat step
8 behind.

10

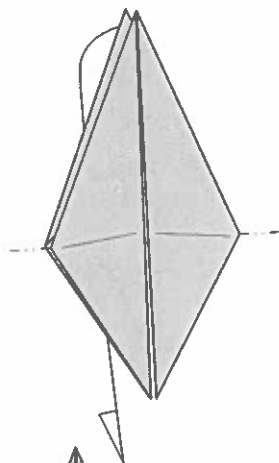

11

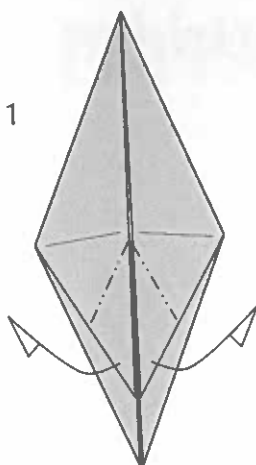

12

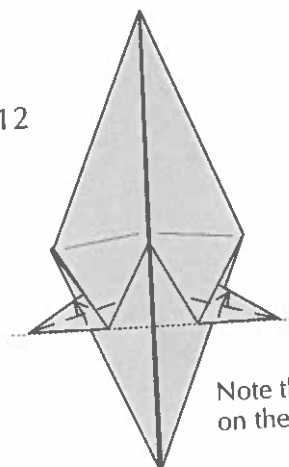

Note the legs lie on the same line.

13

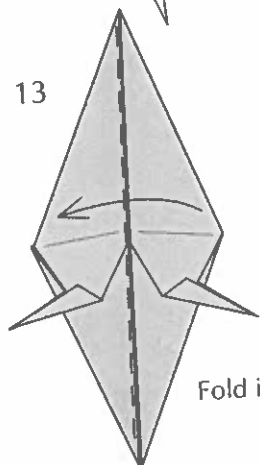

Fold in half and rotate.

14

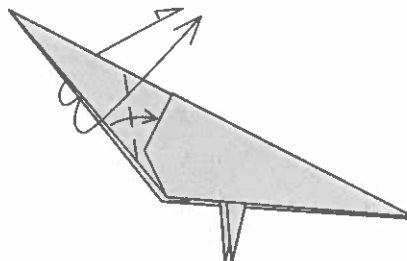

Outside-reverse-fold.

15

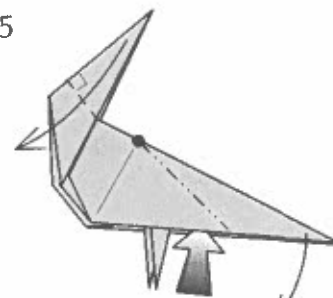

Reverse-fold the tail. Note the right angle at the head.

16

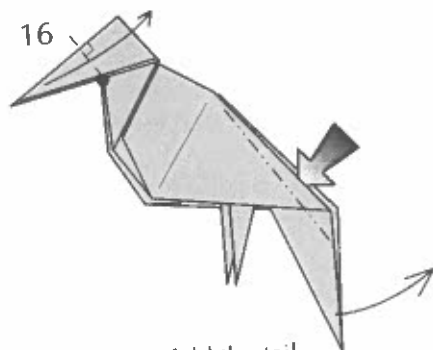

Reverse-fold the tail.

17

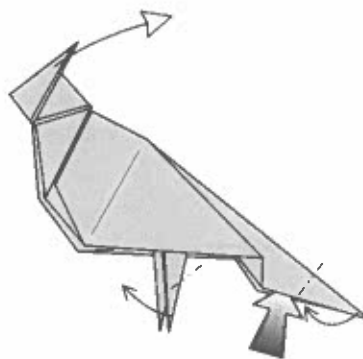

Unfold at the head. Reverse-fold the feet and tail. Repeat behind.

18

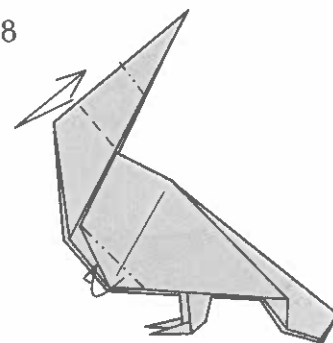

Make two outside reverse folds for the head. Repeat behind at the wing.

19

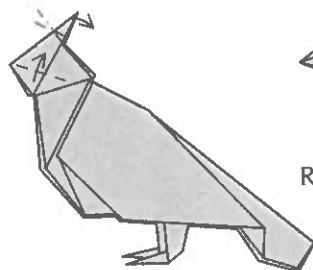

Crimp-fold the tip. Repeat behind.

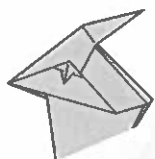

Repeat behind.

20

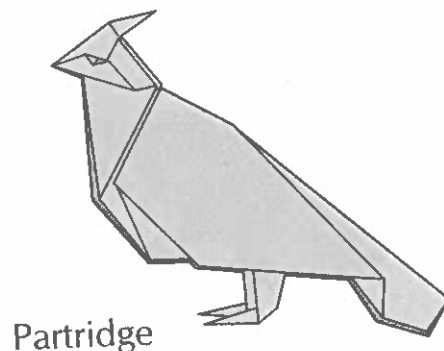

Partridge

Turtle Dove

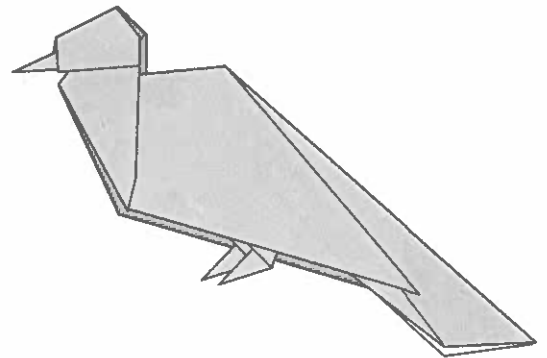
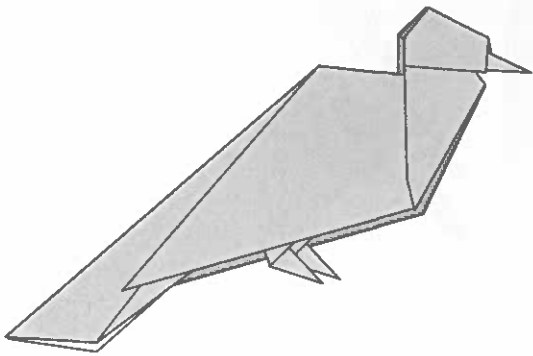

On the second day of Christmas,
my true love sent to me
Two turtle doves,
And a partridge in a pear tree.

1

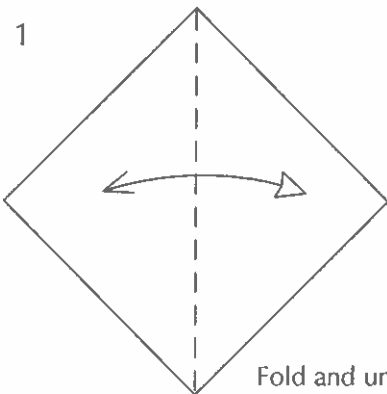

Fold and unfold.

2

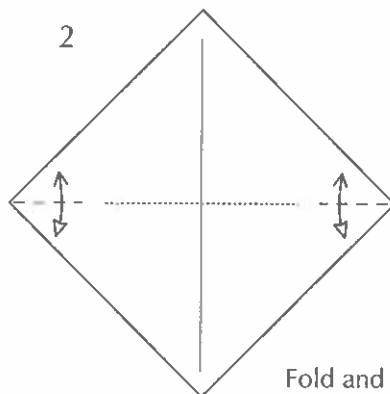

Fold and unfold
at the corners.

3

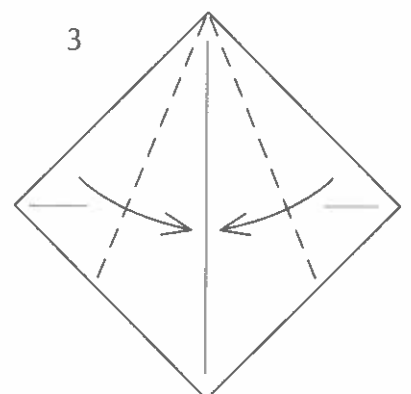

4

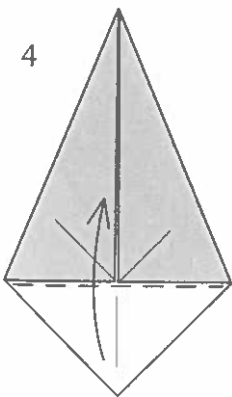

5

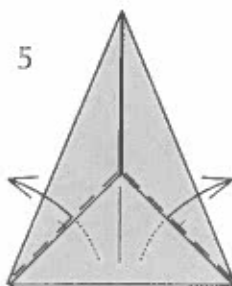

6

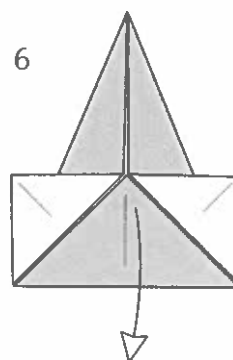

Unfold.

7

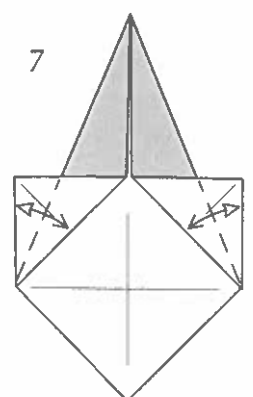

Fold and unfold.

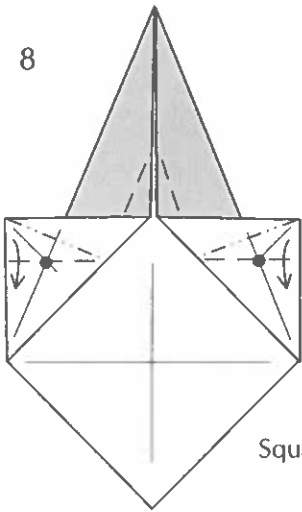

Squash folds.

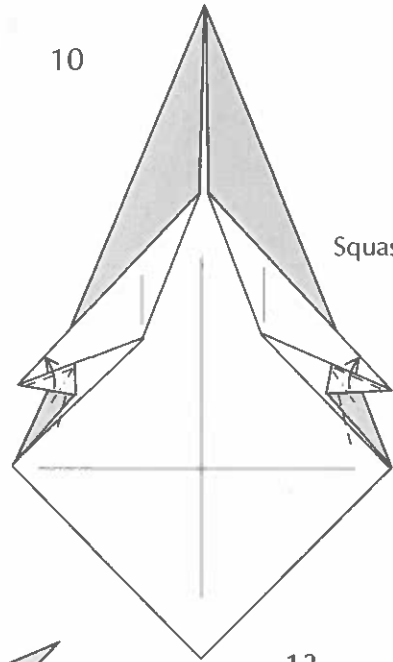
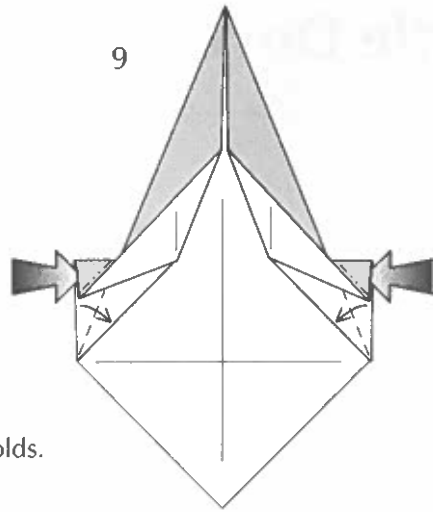

Squash folds.

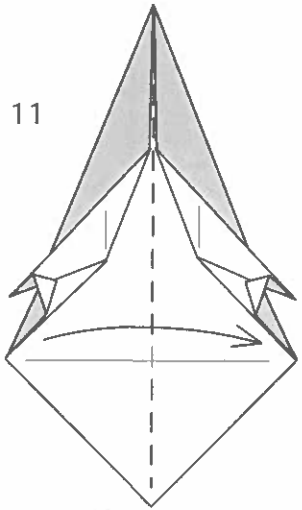

Rotate.

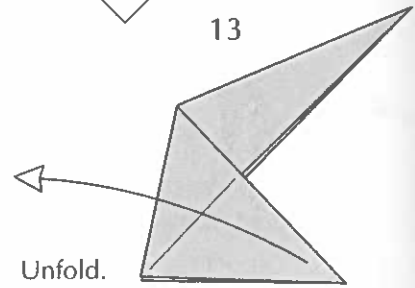
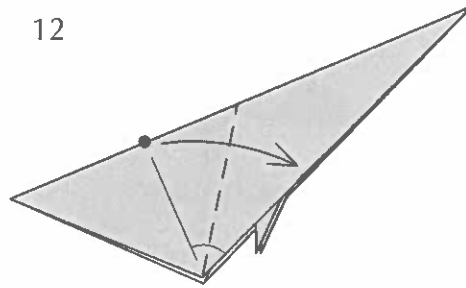

Unfold.

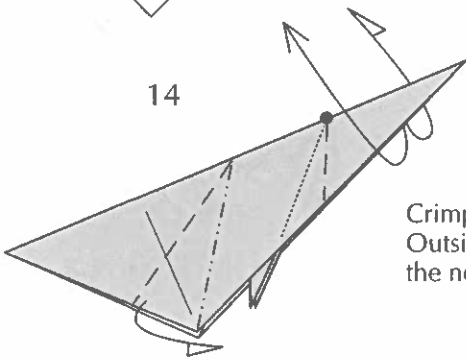

Crimp-fold the tail.
Outside-reverse-fold
the neck.

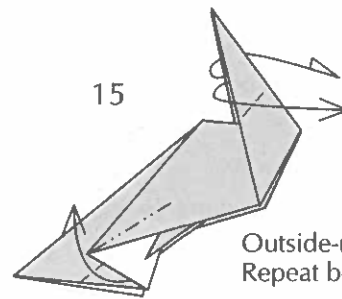

Outside-reverse-fold the head.
Repeat behind at the tail.

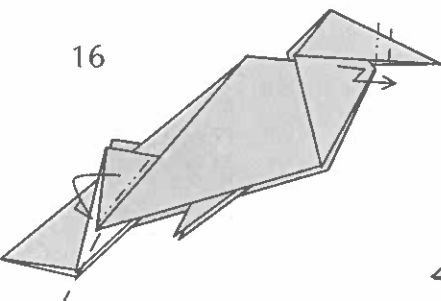

Crimp-fold the beak.
Repeat behind at the tail.

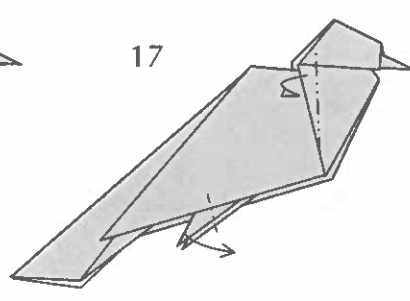

Reverse-fold the feet. Repeat
behind at the feet and neck.

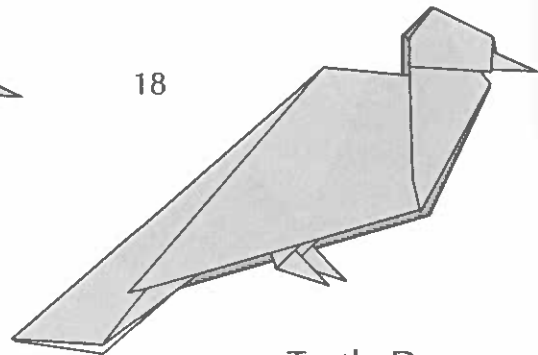

Turtle Dove

French Hen

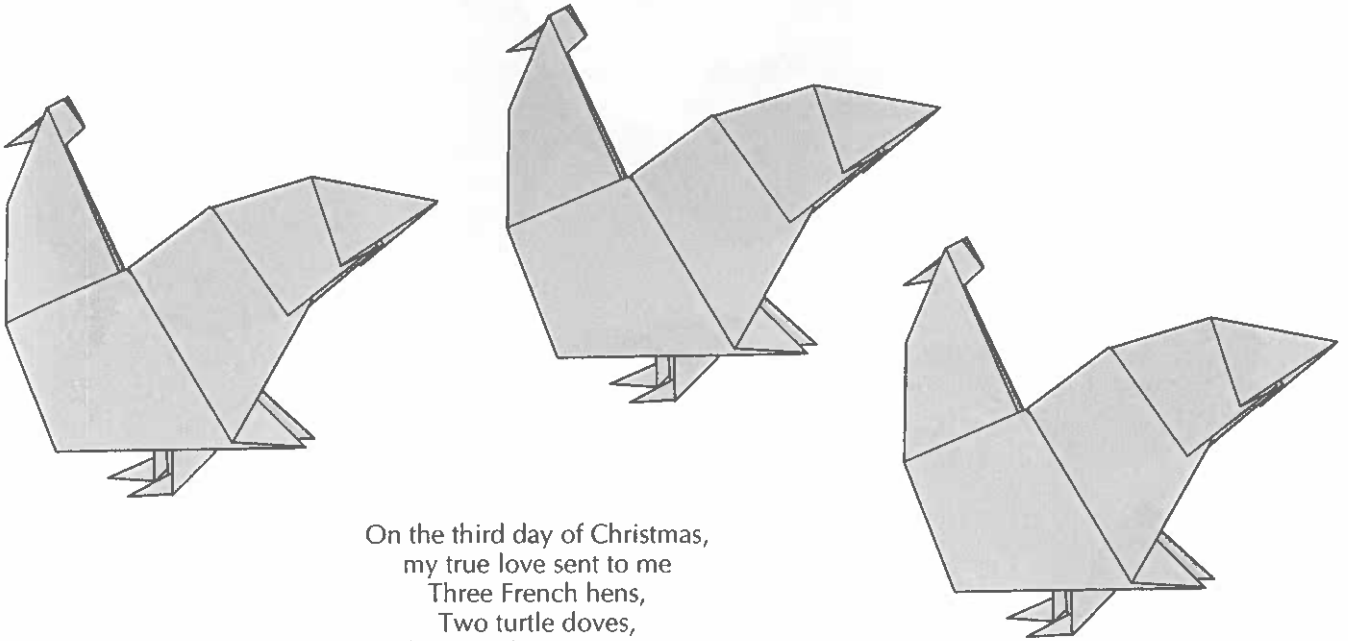

On the third day of Christmas,
 my true love sent to me
 Three French hens,
 Two turtle doves,
 And a partridge in a pear tree.

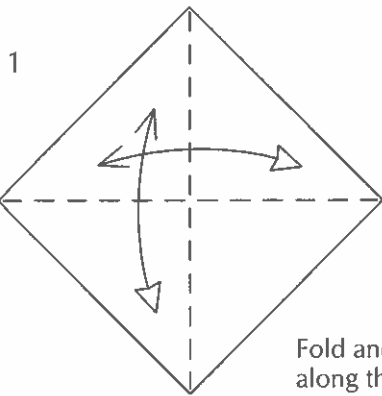

Fold and unfold
 along the diagonals

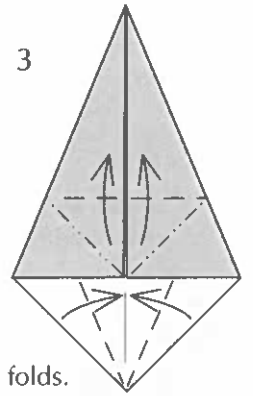
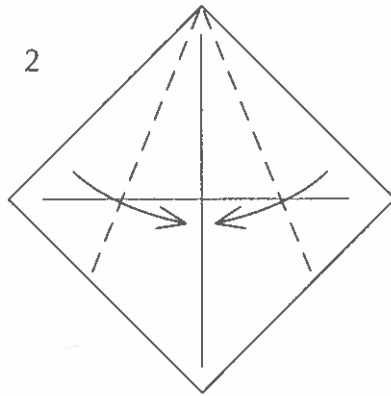

Squash folds.

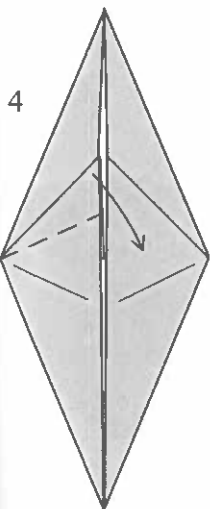

Squash-fold.

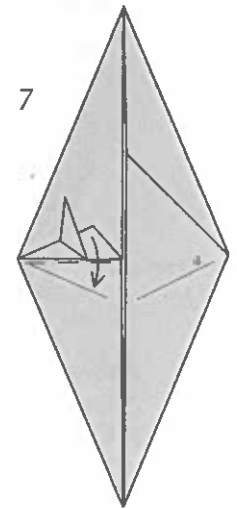
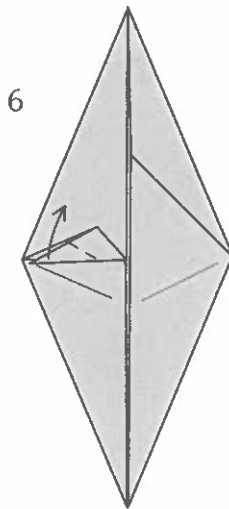
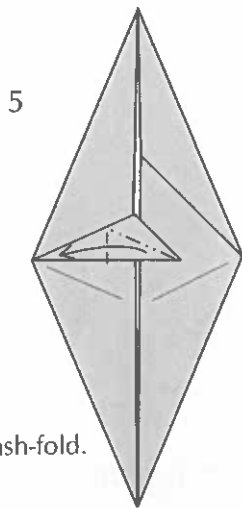

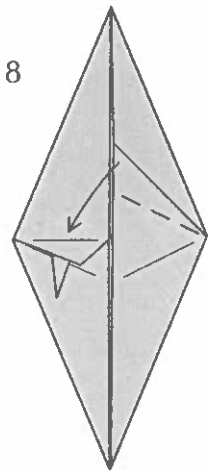

8 Repeat steps 4-7 on the right.

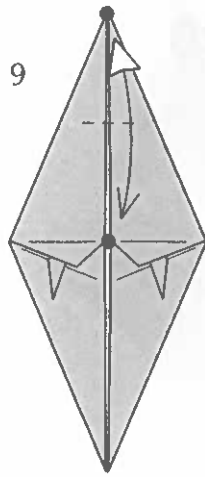

9 Fold and unfold.

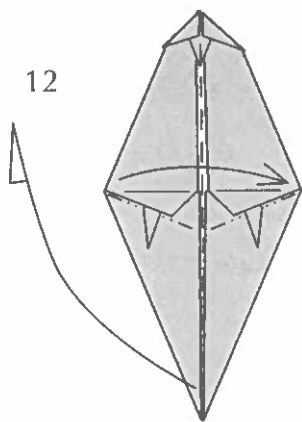
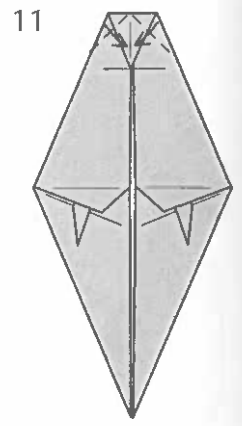
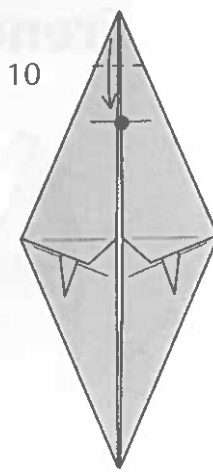

12 Lift the bottom up while folding in half.

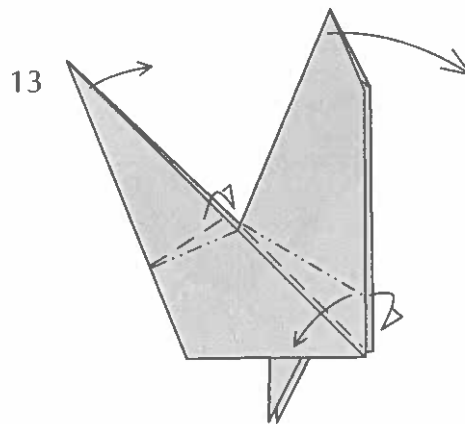

13 Crimp-fold inside for the neck and crimp-fold outside for the tail.

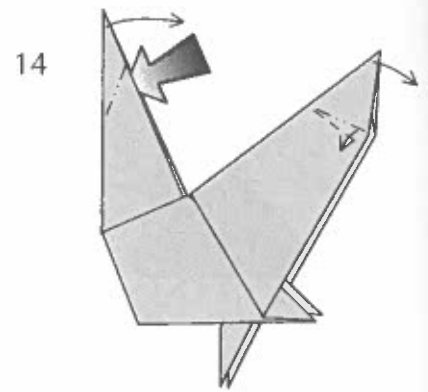

14 Reverse-fold at the head and crimp-fold at the tail.

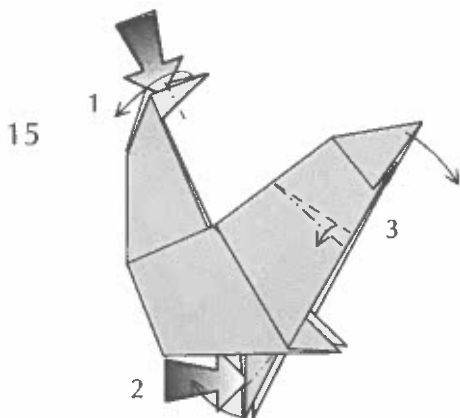

1. Reverse-fold.
2. Reverse-fold, repeat behind.
3. Crimp-fold.

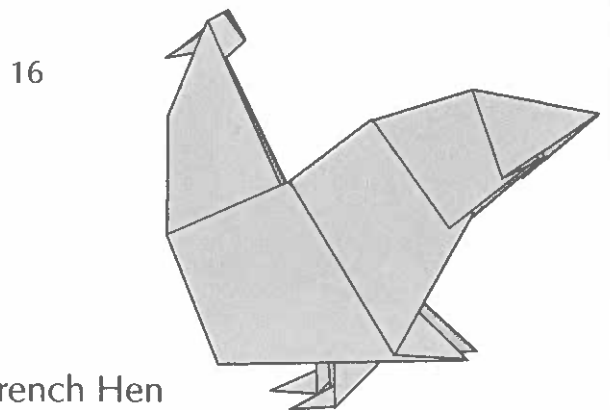

16 French Hen

Calling Bird

11

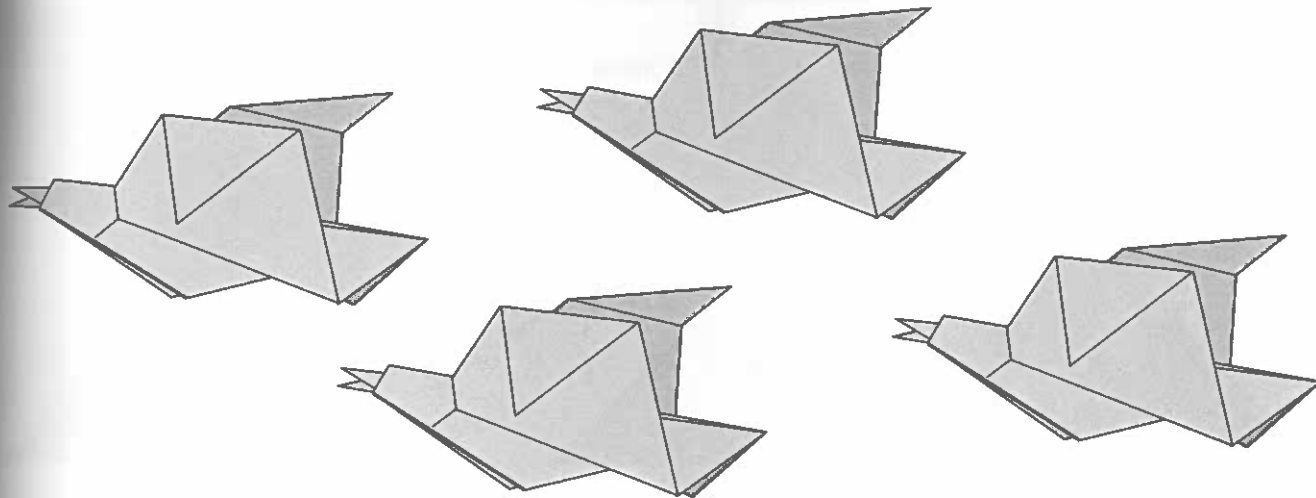
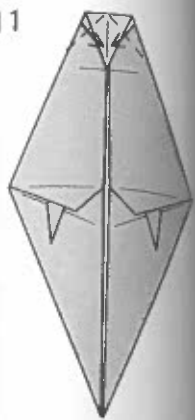

On the fourth day of Christmas,
my true love sent to me
Four calling birds,
Three French hens,
Two turtle doves,
And a partridge in a pear tree.

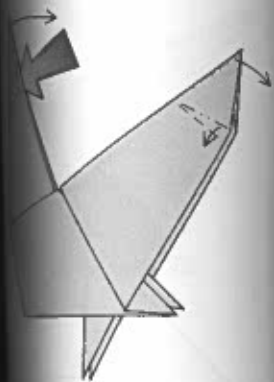

Reverse-fold at the head
and crimp-fold at the tail.

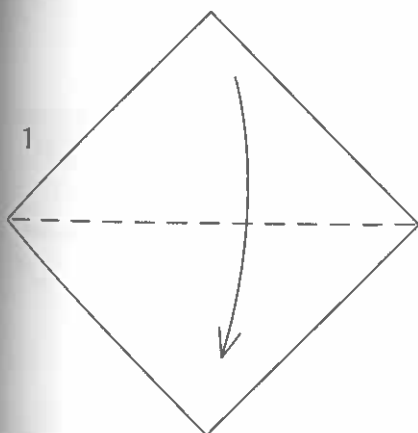

1

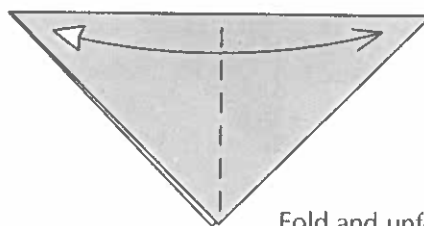

2

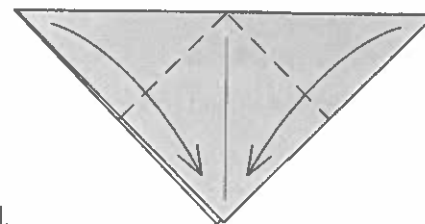

3

Fold and unfold.

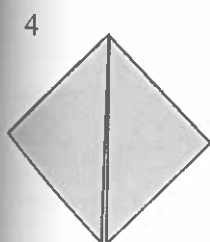

4

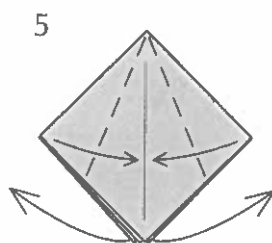

5

Lift the corners from behind.

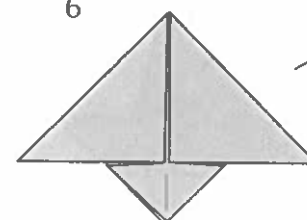

6



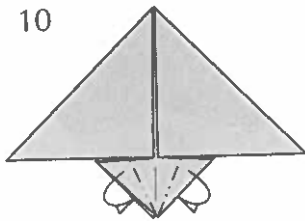
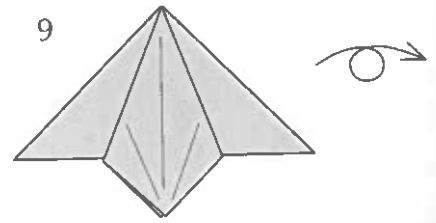
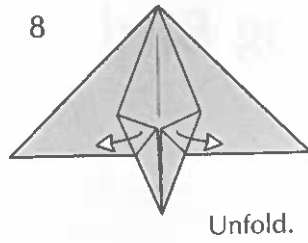
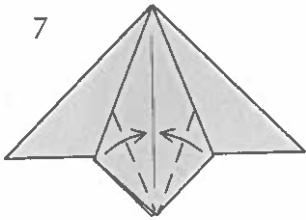

Fold inside.

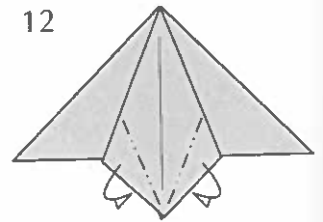
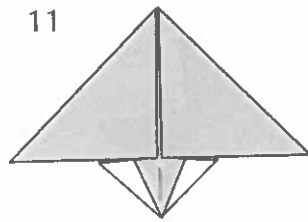

Reverse-fold the paper inside.

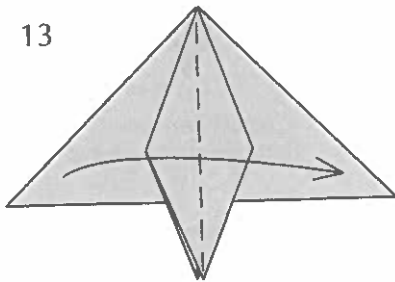

Fold in half and rotate.

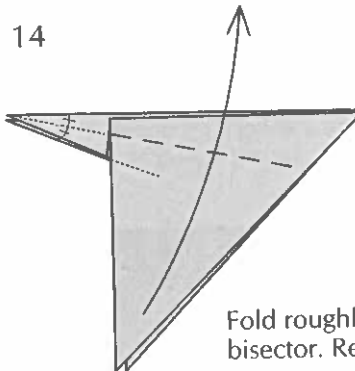

Fold roughly along the bisector. Repeat behind.

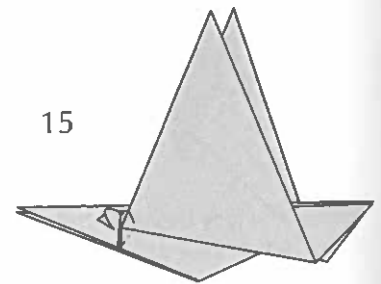

Fold behind. Repeat behind.

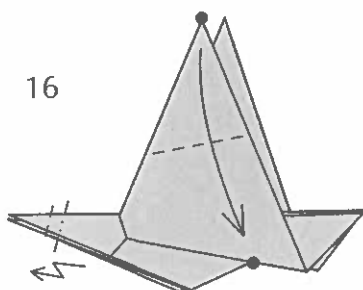

Crimp-fold the beak. Repeat behind at the wing.

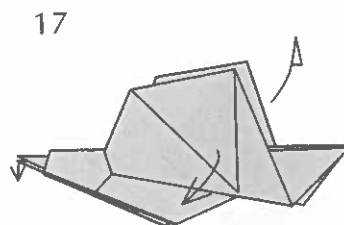

Spread the wings and beak.

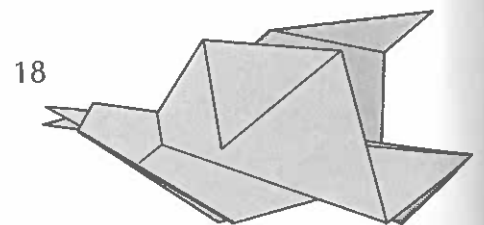

Calling Bird

Golden Ring

On the fifth day of Christmas,
 my true love sent to me
 Five golden rings,
 Four calling birds,
 Three French hens,
 Two turtle doves,
 And a partridge in a pear tree.

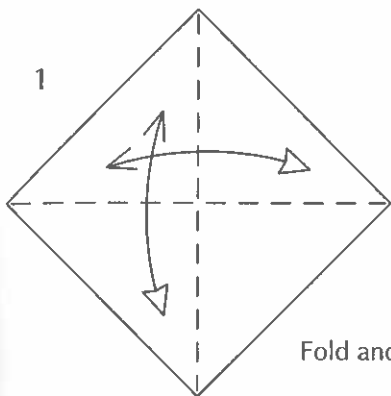
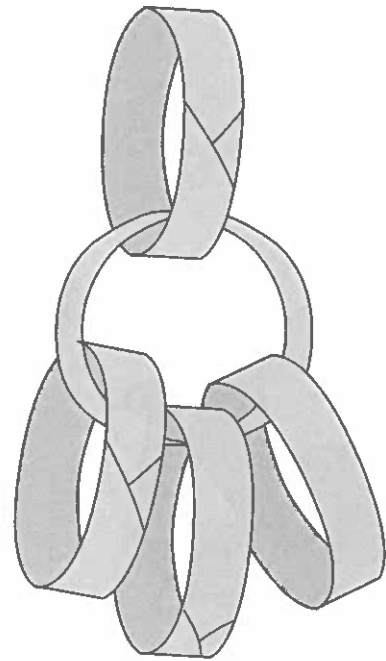

Fold and unfold.

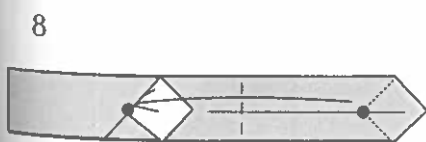
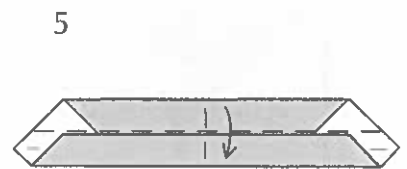
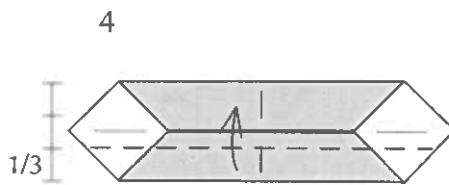
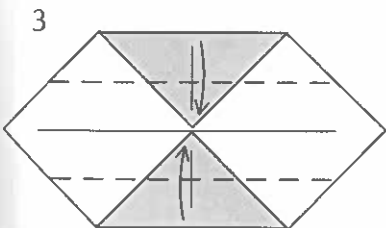
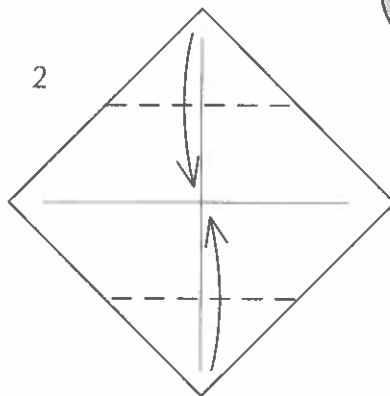

Tuck inside.

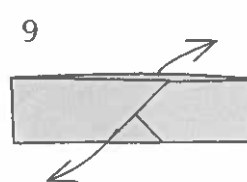

Make the ring round.

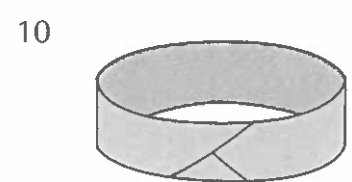

Golden Ring

Goose

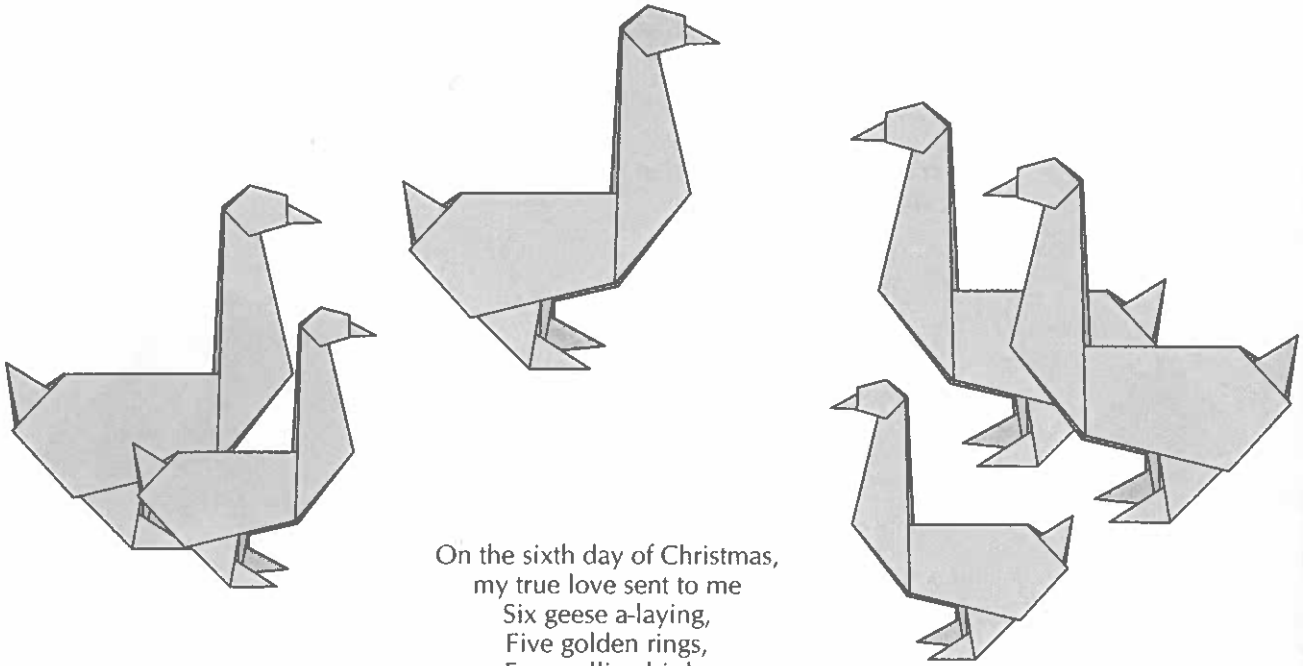

On the sixth day of Christmas,
my true love sent to me
Six geese a-laying,
Five golden rings,
Four calling birds,
Three French hens,
Two turtle doves,
And a partridge in a pear tree.

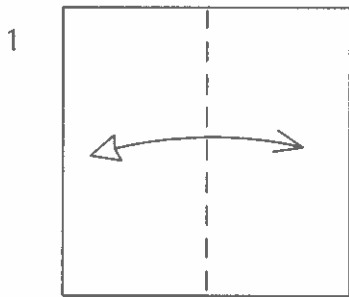

Fold and unfold.

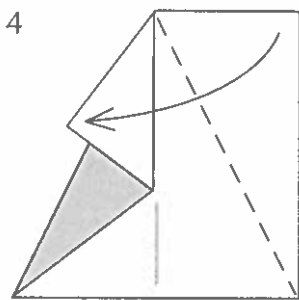
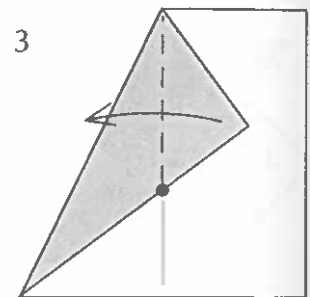
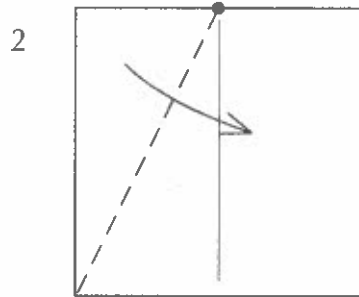

Repeat steps 2-3 on the right.

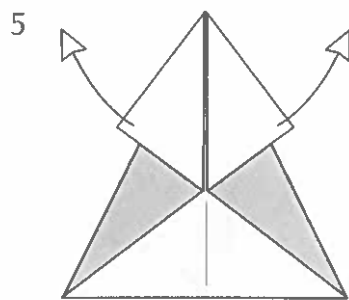

Unfold.

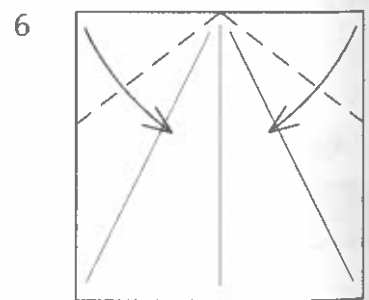

Fold along the creases.

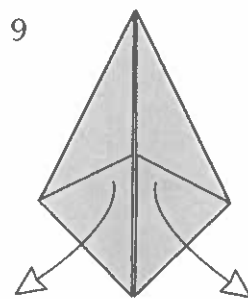
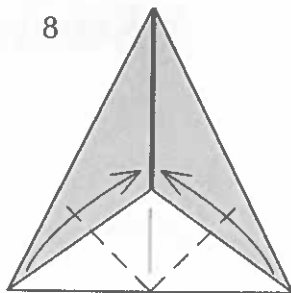
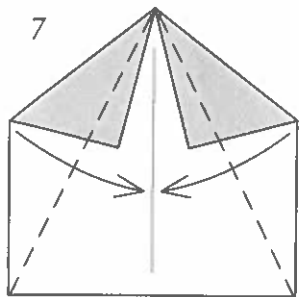

Unfold.

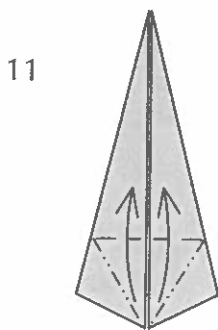
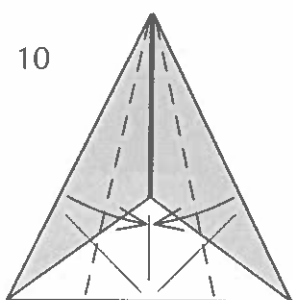

Squash folds.

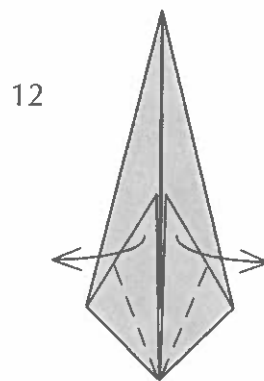

Squash folds.

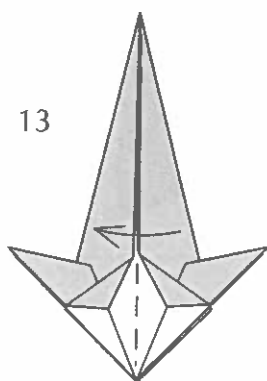

Fold in half and rotate.

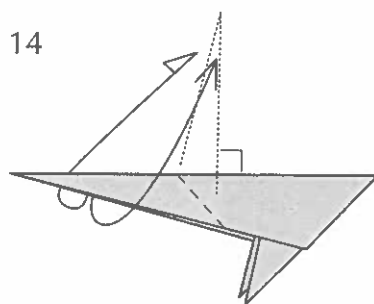

Outside-reverse-fold
at a right angle.

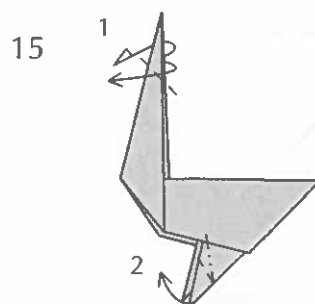

1. Outside-reverse-fold.
2. Crimp-fold, repeat behind.

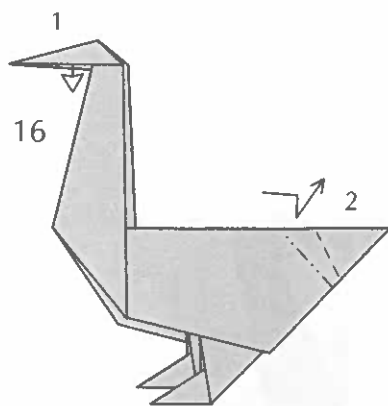

1. Pull out and repeat behind.
2. Crimp-fold the tail.

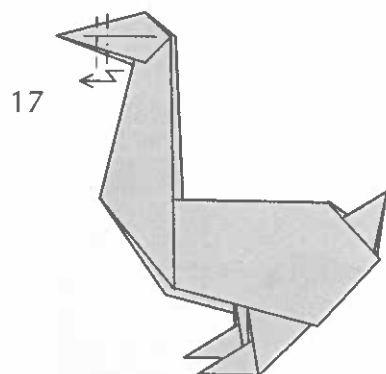

Crimp-fold the beak.

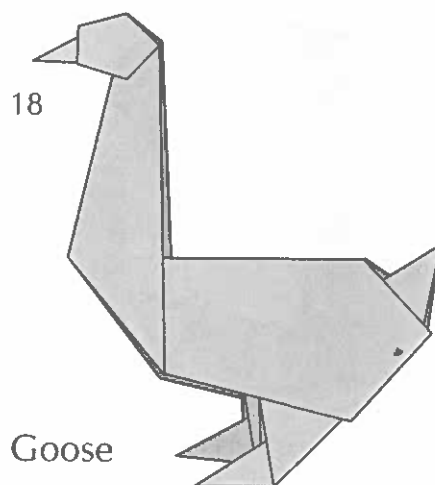

Goose

Swan

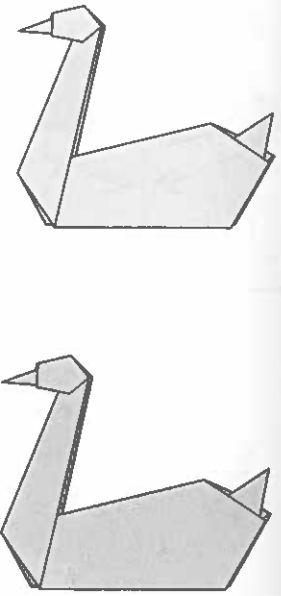
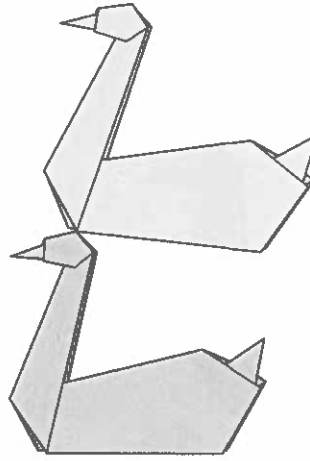
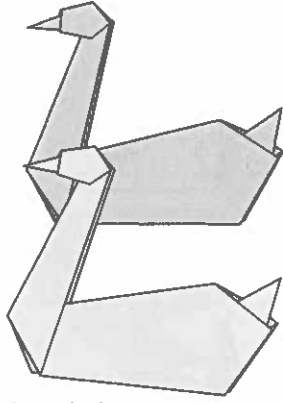
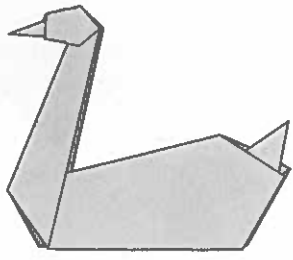

On the seventh day of Christmas,
my true love sent to me
Seven swans a-swimming,
Six geese a-laying,
Five golden rings,
Four calling birds,
Three French hens,
Two turtle doves,
And a partridge in a pear tree.

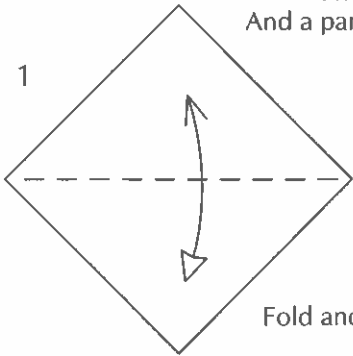

Fold and unfold.

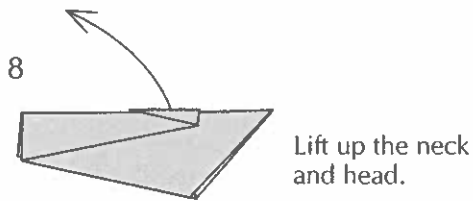
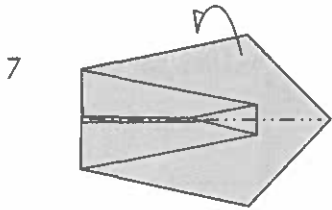
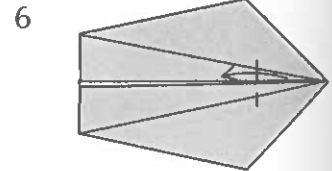
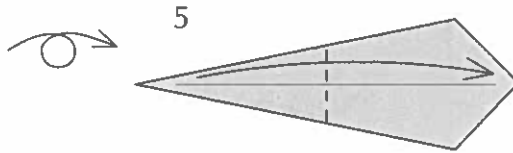
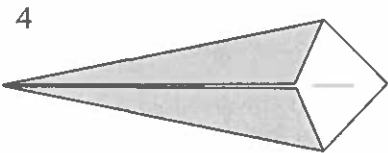
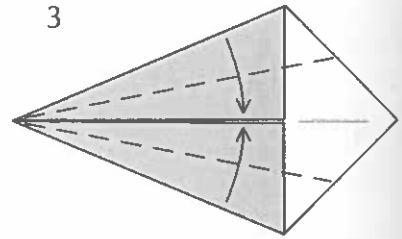
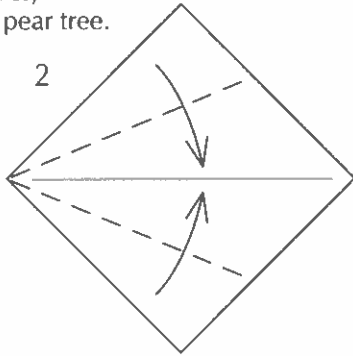

Lift up the neck and head.

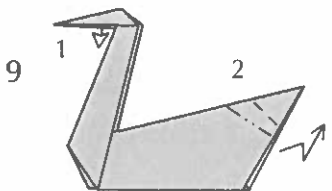

1. Pull out and repeat behind.
2. Crimp-fold the tail.

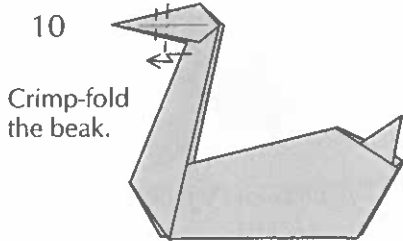

Crimp-fold the beak.

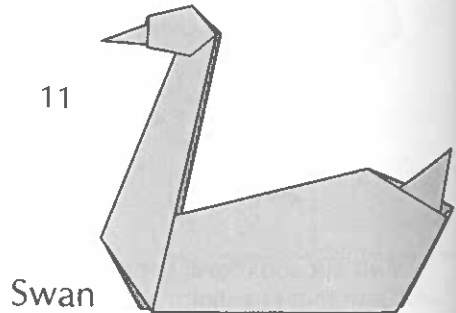

Maid's a-Milking

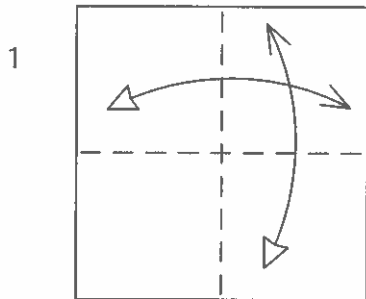

Fold and unfold.

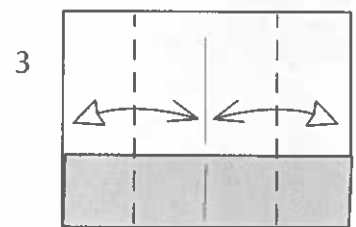
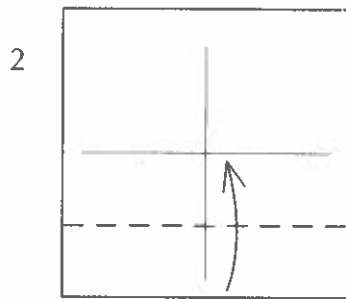

Fold and unfold.

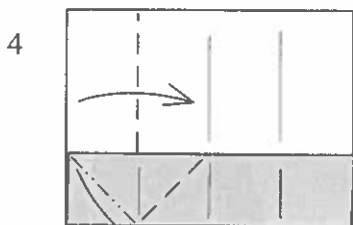

Squash-fold.

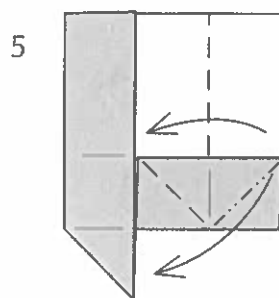

Squash-fold.

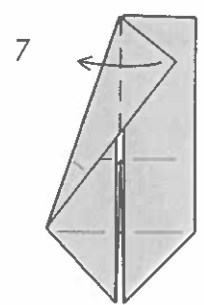
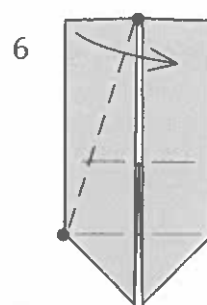

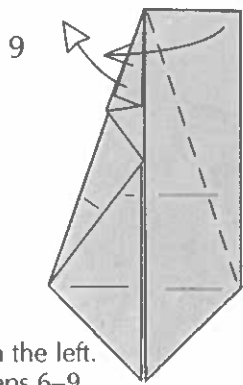
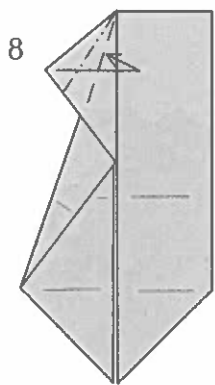

Unfold on the left.
Repeat steps 6–9
on the right.

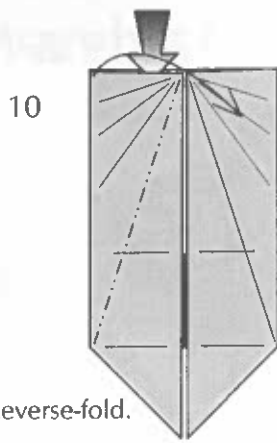

Reverse-fold.

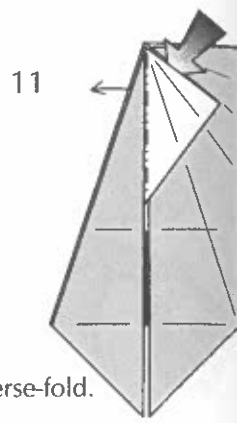

Reverse-fold.

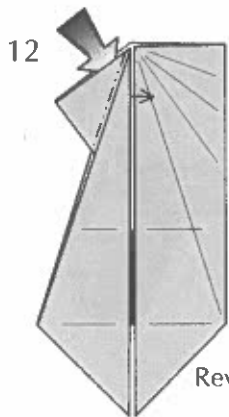

Reverse-fold.

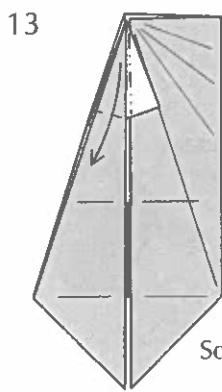

Squash-fold.

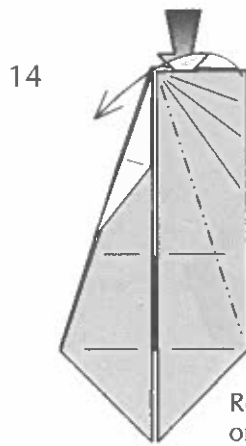

Repeat steps 10–13
on the right.

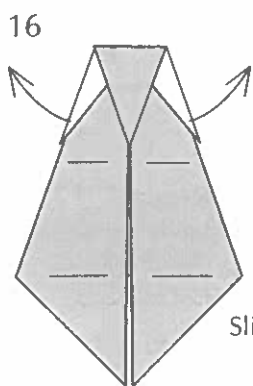
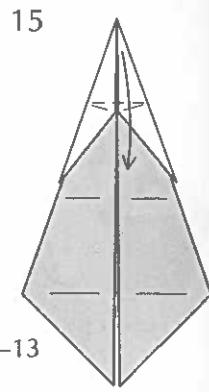

Slide the arms.

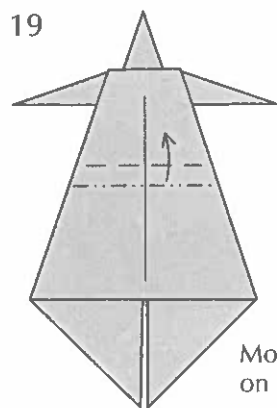
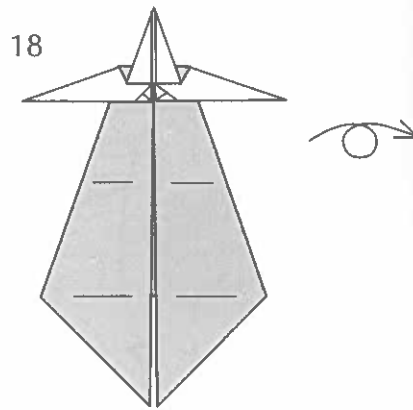
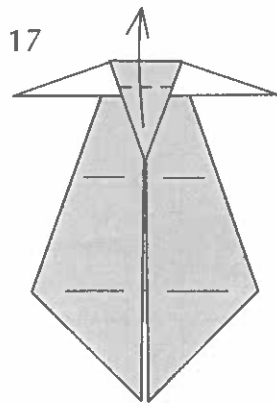

Mountain-fold
on the crease.

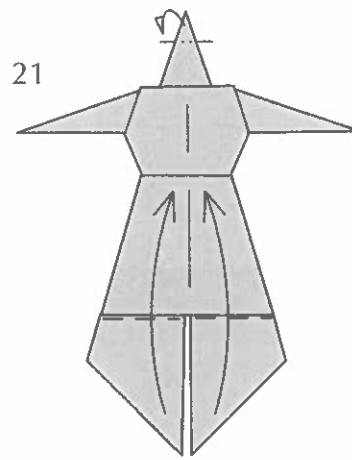
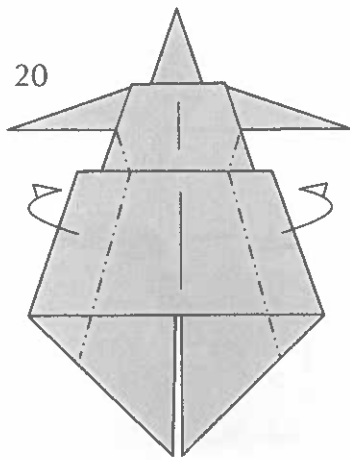

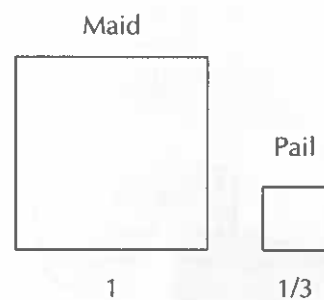
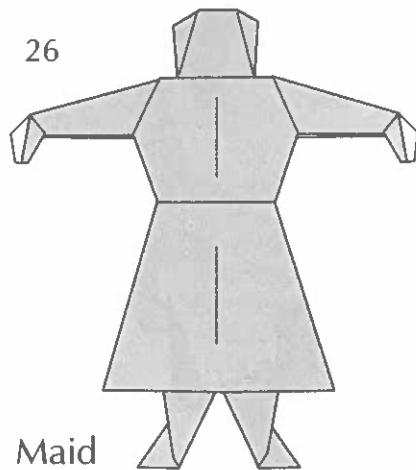
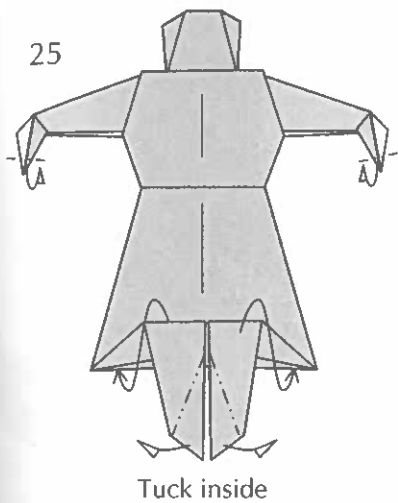
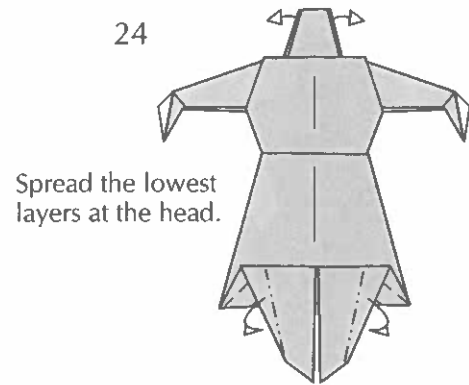
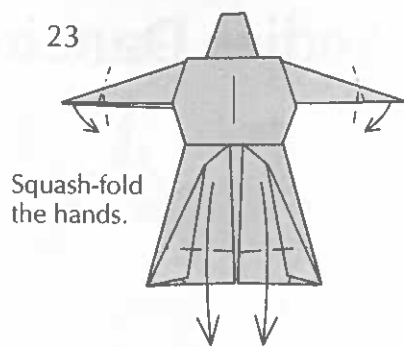
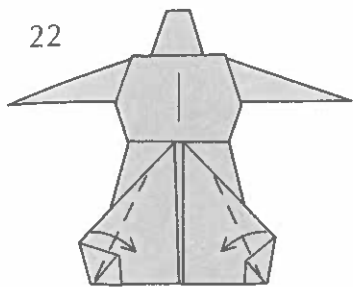

Pail

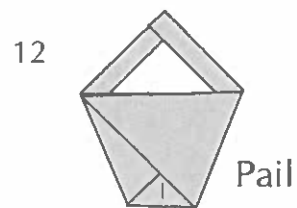
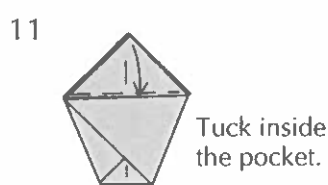
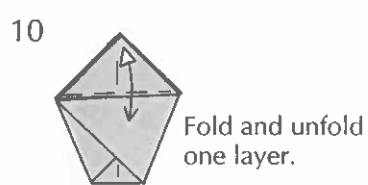
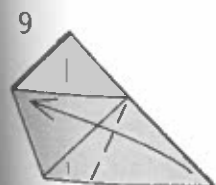
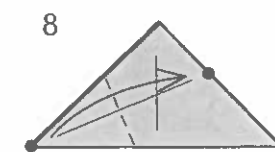
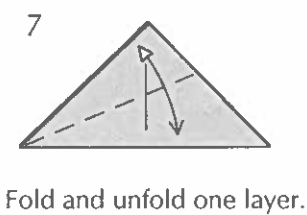
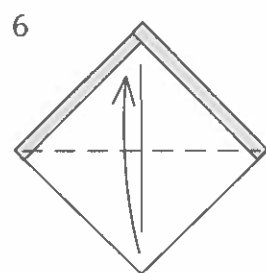
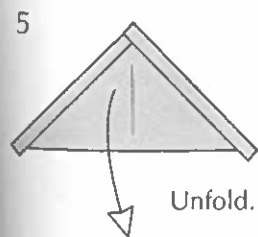
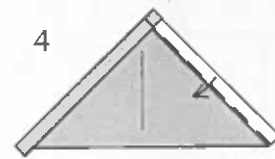
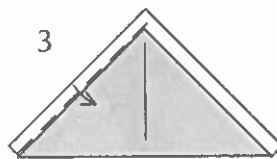
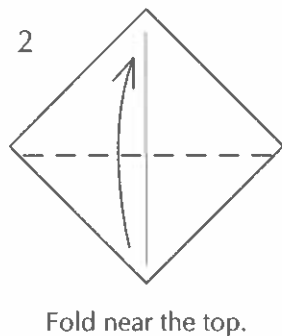
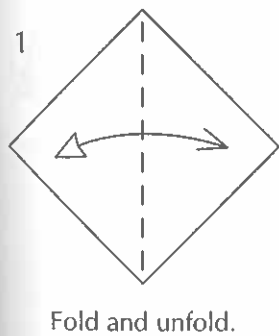

Ladies Dancing

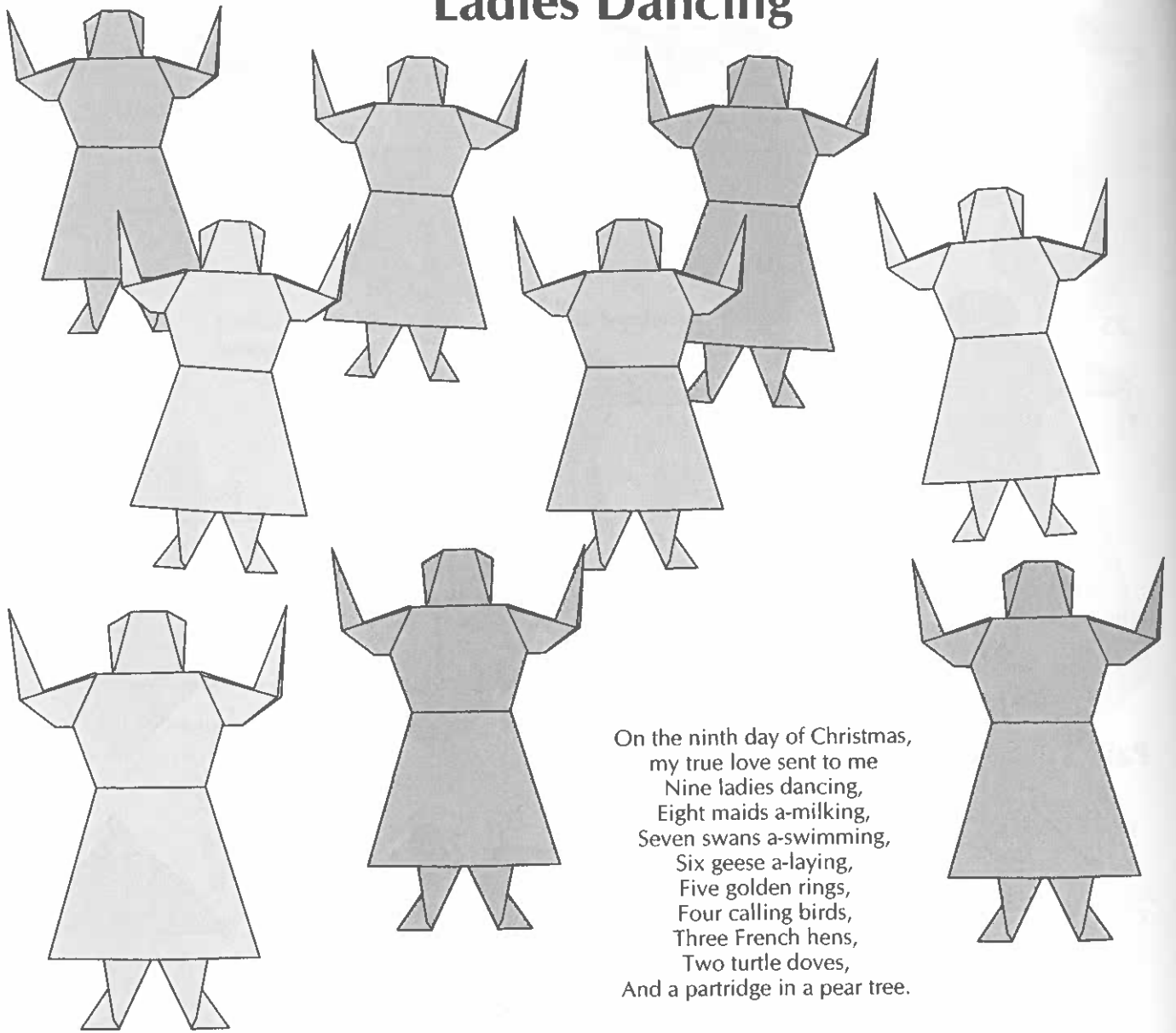

On the ninth day of Christmas,
 my true love sent to me
 Nine ladies dancing,
 Eight maids a-milking,
 Seven swans a-swimming,
 Six geese a-laying,
 Five golden rings,
 Four calling birds,
 Three French hens,
 Two turtle doves,
 And a partridge in a pear tree.

Begin with the Maid, but do not fold the hands.

1

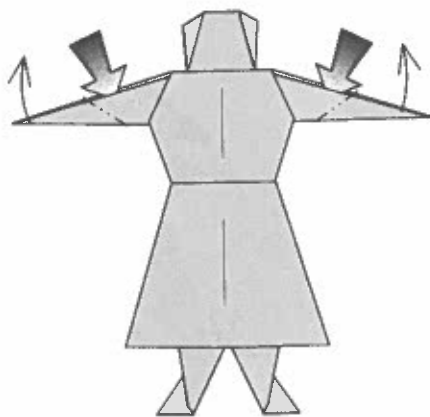

Reverse folds.

2

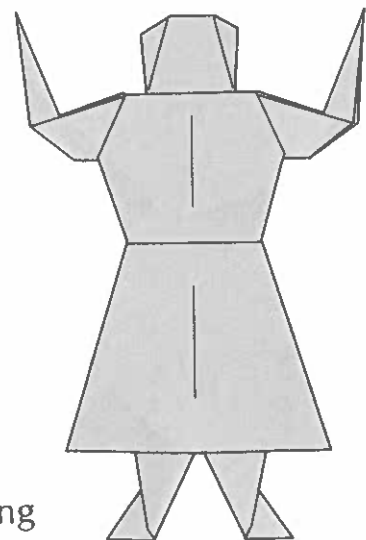

Lady Dancing

Lords a-Leaping

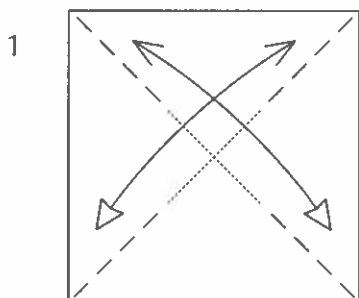
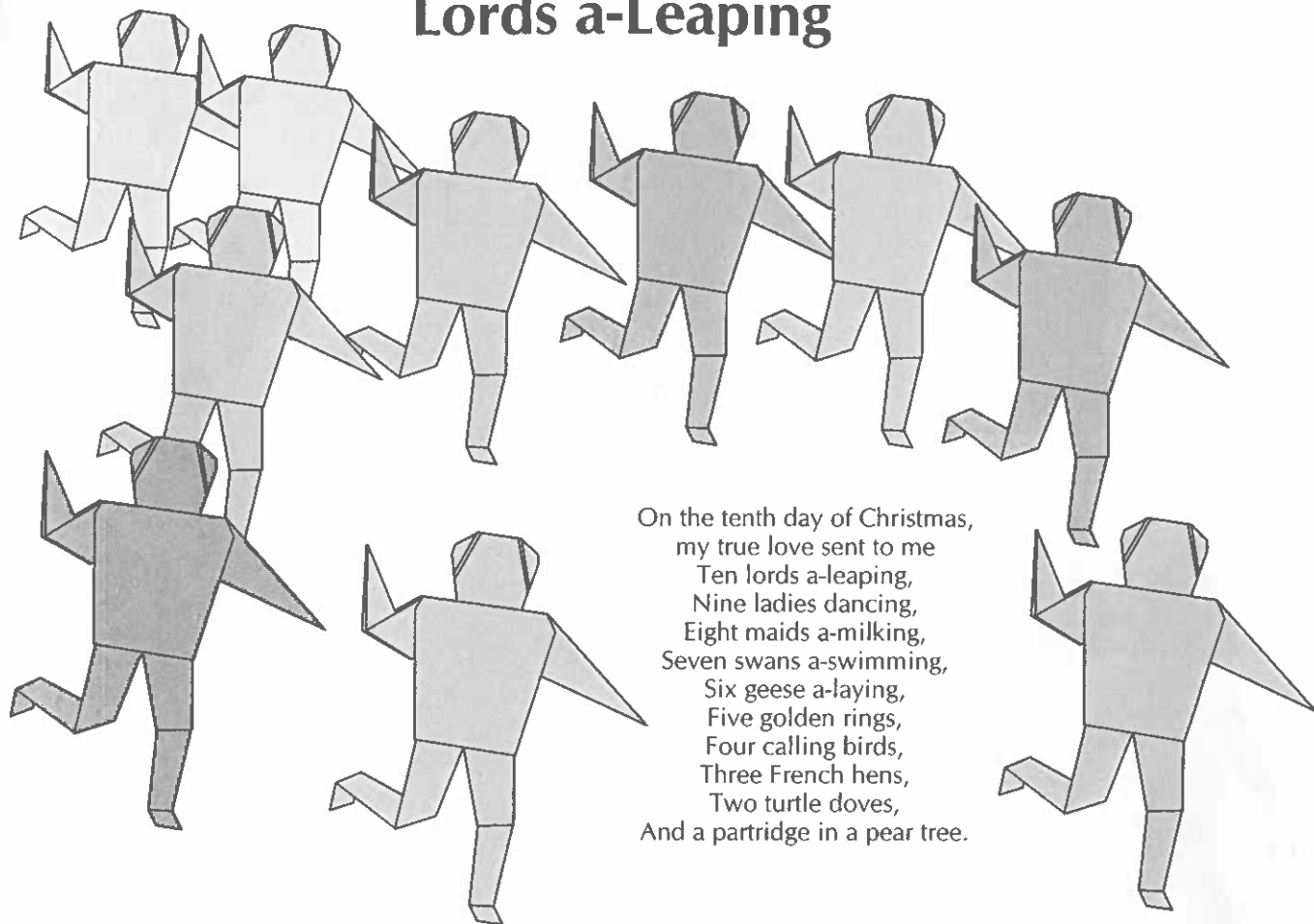

Fold and unfold but do not crease in the center.

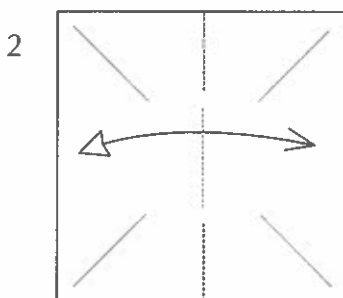

Fold and unfold but do not crease in the center.

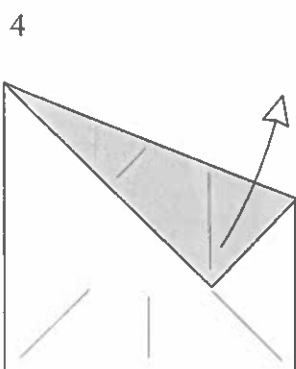
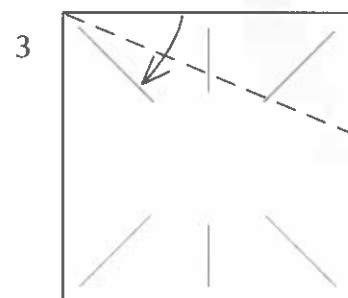

Unfold.

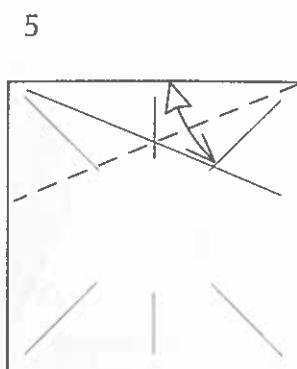

Fold and unfold.

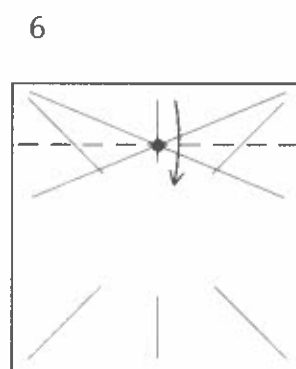

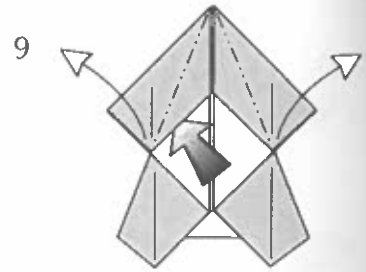
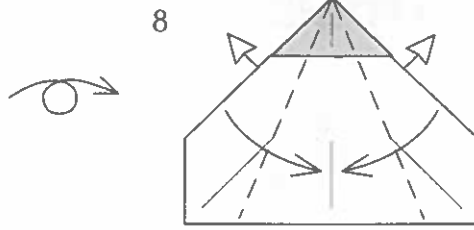
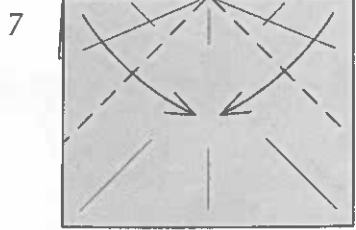

Spread.

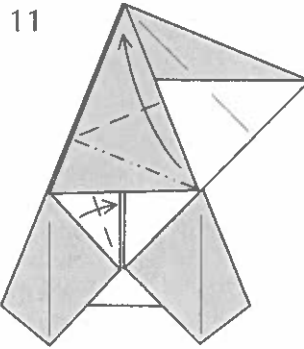
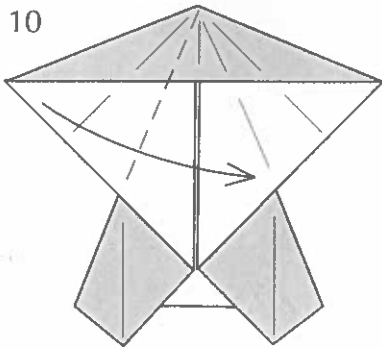

Squash-fold.

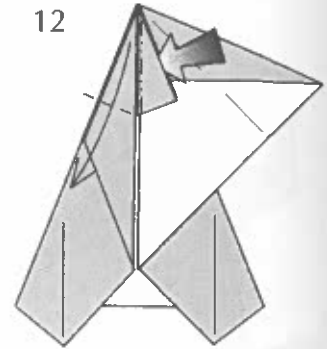

Squash-fold.

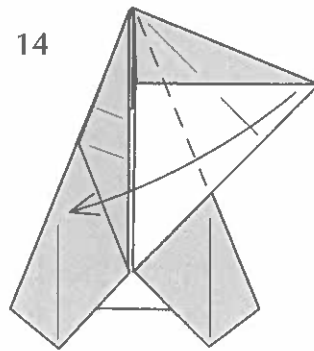
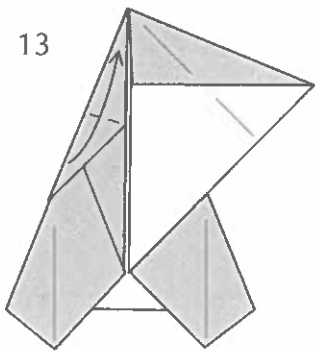

Repeat steps 10–13
on the right.

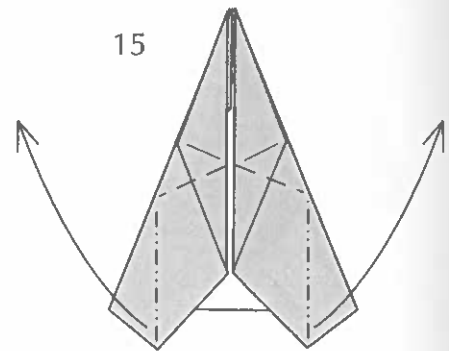

Petal-fold.

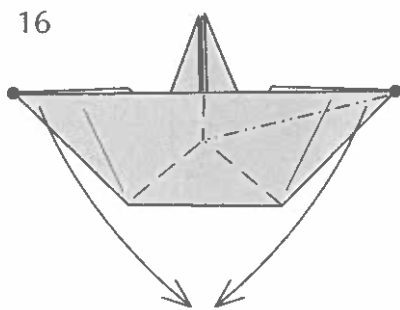

Rabbit-ear so the dots
meet at the bottom.

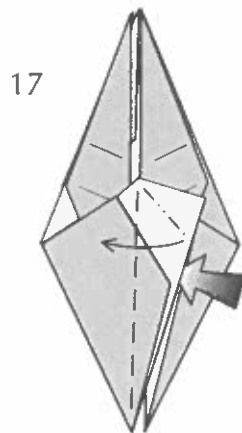

Squash-fold.

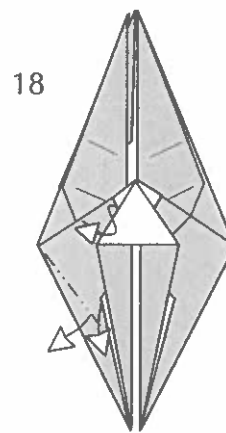

Pull out.

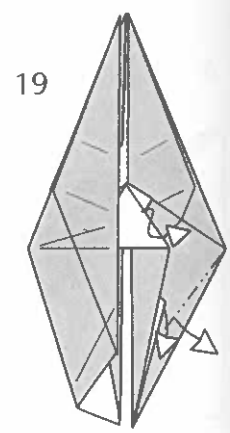

Pull out.

20

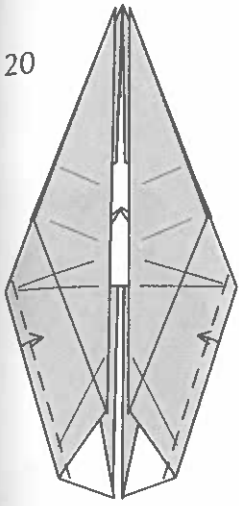

21

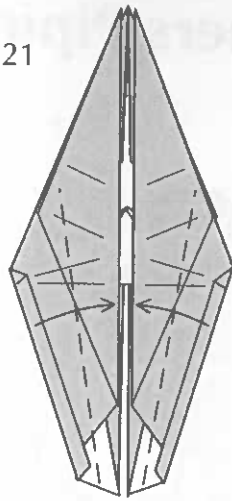

22

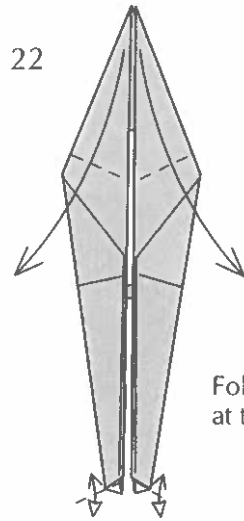

Fold and unfold at the feet.

23

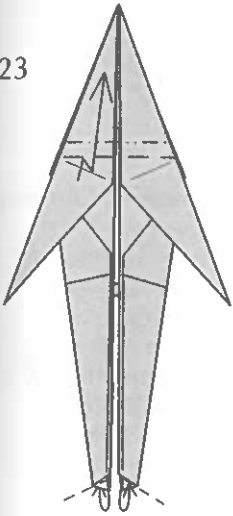

Tuck inside at the feet.

24

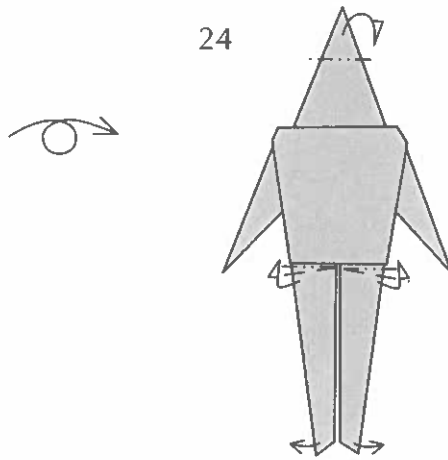

25

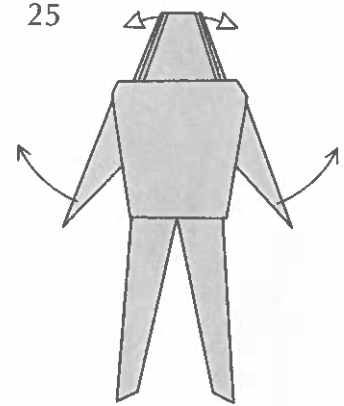

Spread the lowest layers at the head. Slide the arms.

26

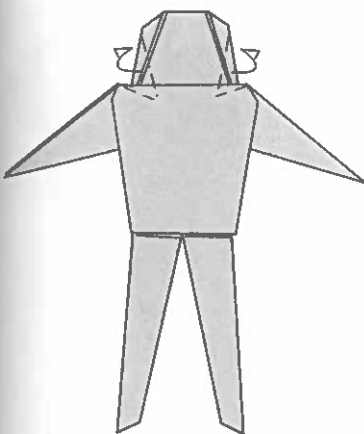

Fold behind at the head.

27

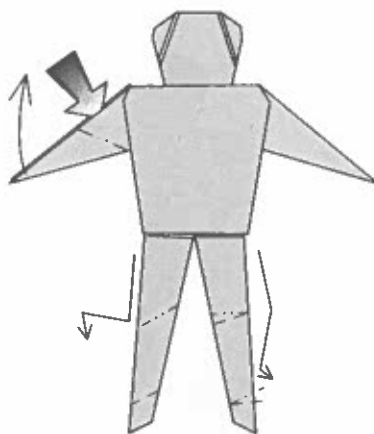

Reverse-fold the arm. Shape the legs with simple mountain and valley folds.

28

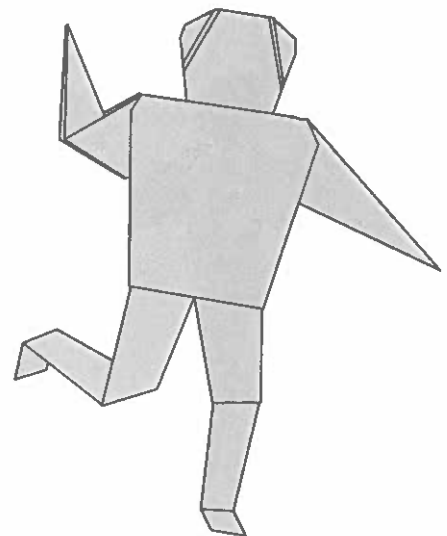

Lord a-Leaping

Pipers Piping

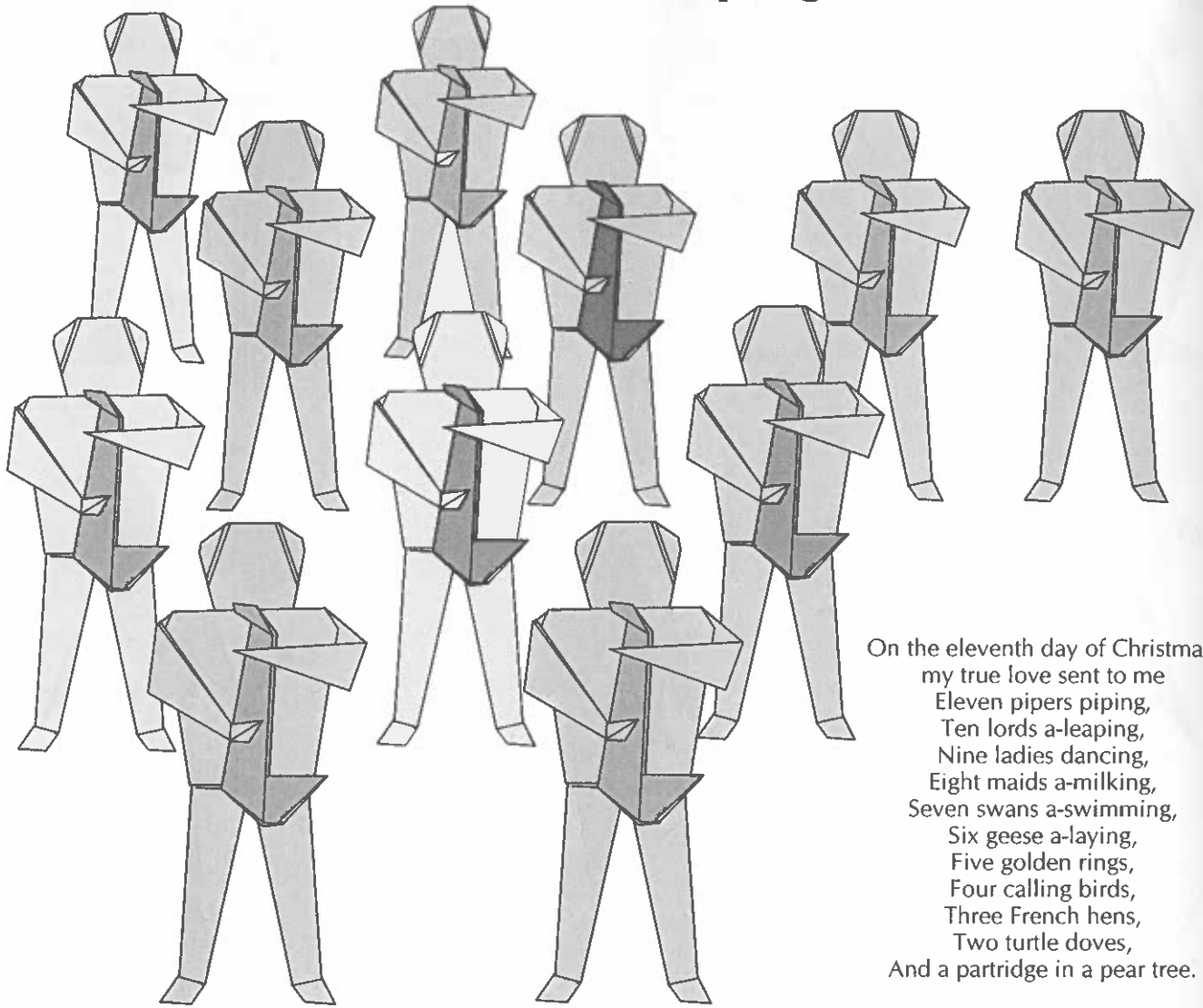

On the eleventh day of Christmas,
 my true love sent to me
 Eleven pipers piping,
 Ten lords a-leaping,
 Nine ladies dancing,
 Eight maids a-milking,
 Seven swans a-swimming,
 Six geese a-laying,
 Five golden rings,
 Four calling birds,
 Three French hens,
 Two turtle doves,
 And a partridge in a pear tree.

Begin with step 27 of the Lord a-Leaping.

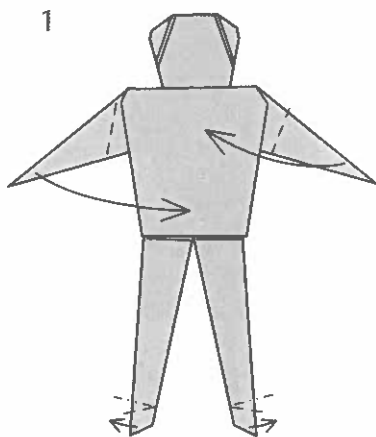

Shape the feet with simple mountain and valley folds.

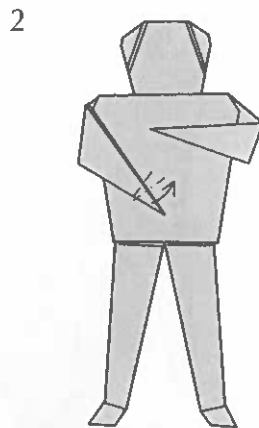

Squash-fold.

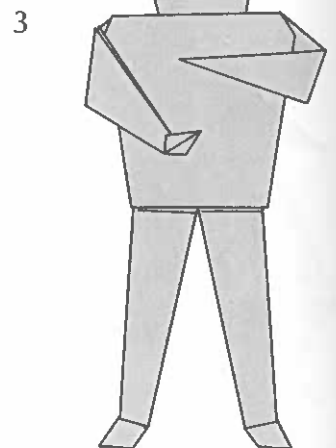

Piper Piping

Piper



1

Pipe



1/3

Pipe

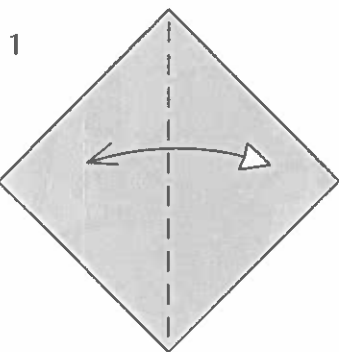

1

Fold and unfold.

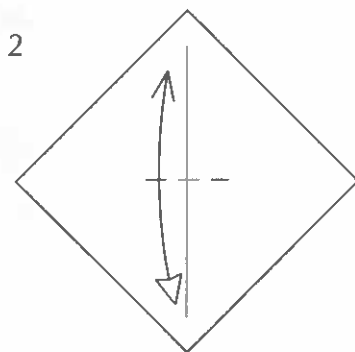

2

Fold and unfold at the center.

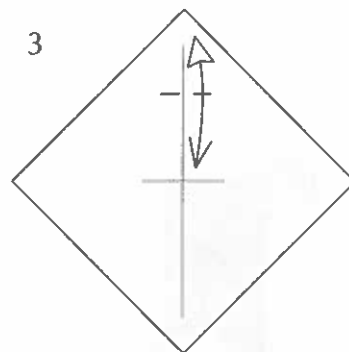

3

Fold and unfold at the center.

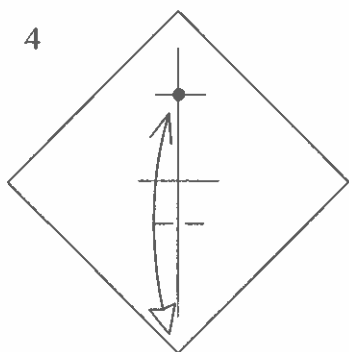

4

Fold and unfold at the center.

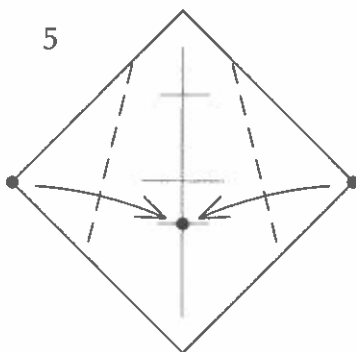

5

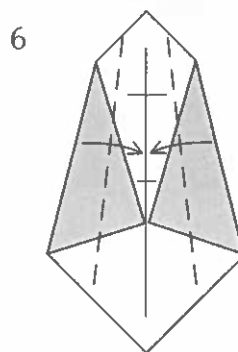

6

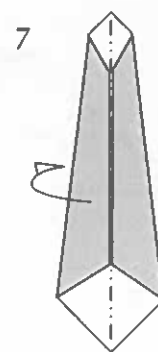

7



8

Reverse-fold at the bottom and outside-reverse-fold at the top.

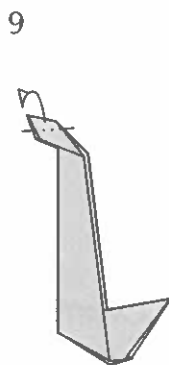

9

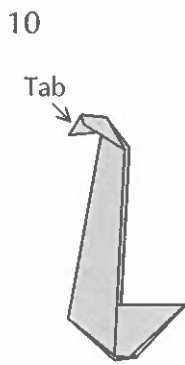

10

Pipe

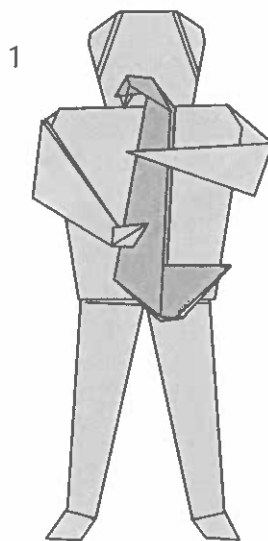

1

Tuck the tab inside.

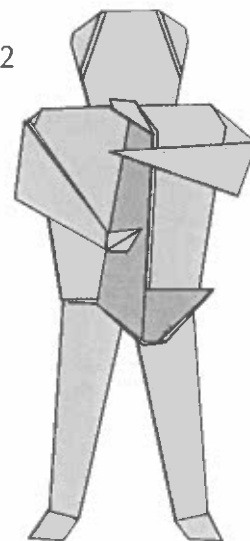

2

Piper Piping

Drummers Drumming

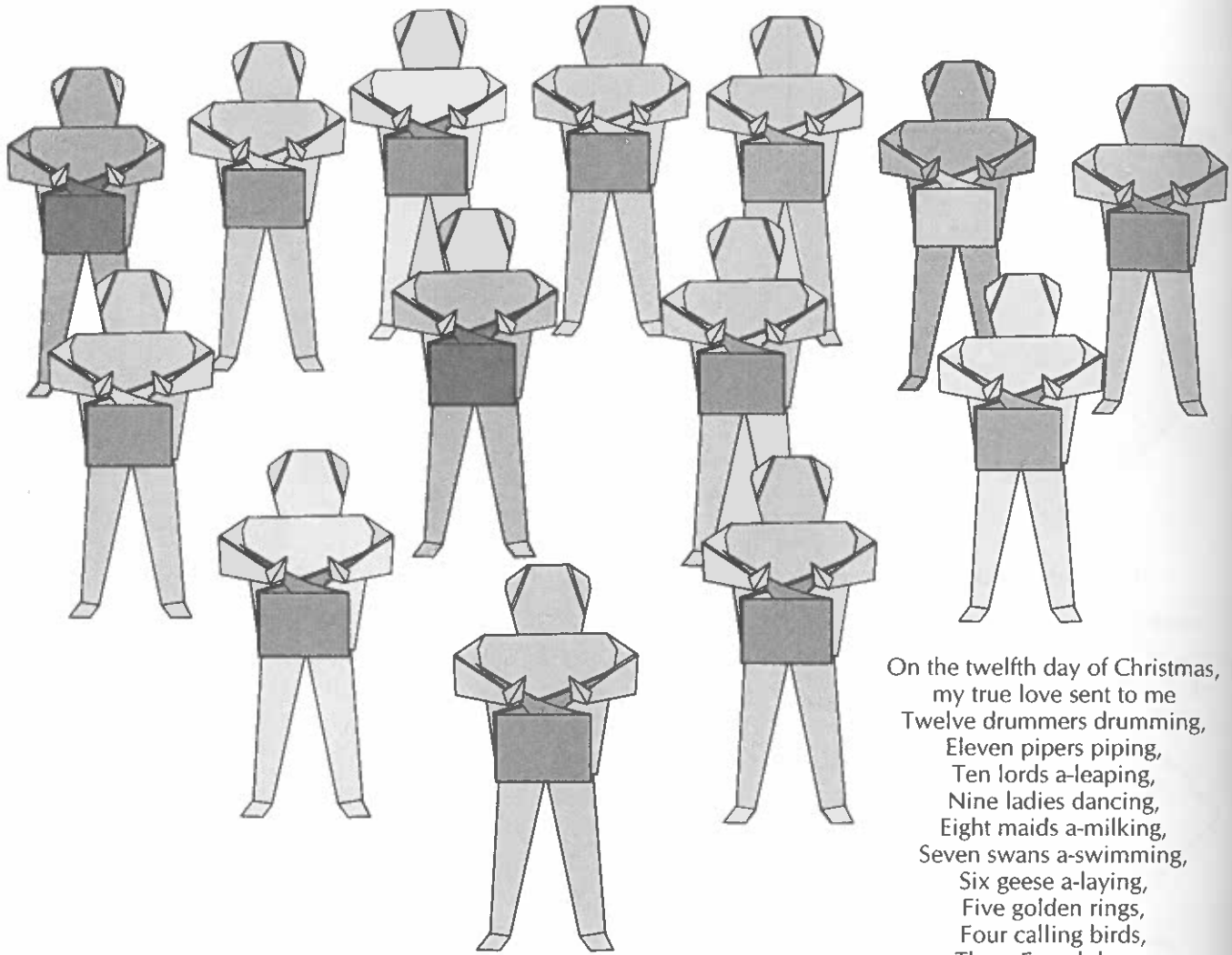

On the twelfth day of Christmas,
 my true love sent to me
 Twelve drummers drumming,
 Eleven pipers piping,
 Ten lords a-leaping,
 Nine ladies dancing,
 Eight maids a-milking,
 Seven swans a-swimming,
 Six geese a-laying,
 Five golden rings,
 Four calling birds,
 Three French hens,
 Two turtle doves,
 And a partridge in a pear tree.

Begin with step 27 of the Lord a-Leaping.

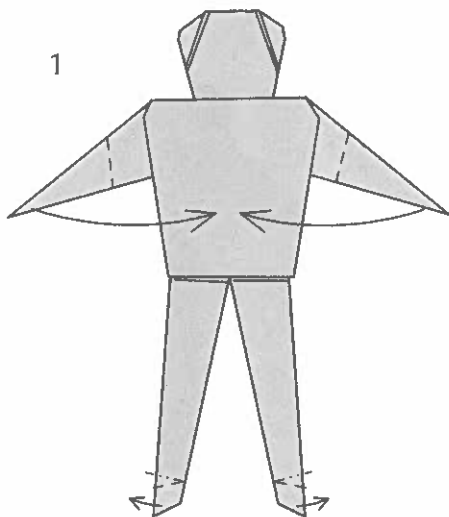

Shape the feet with simple mountain and valley folds.

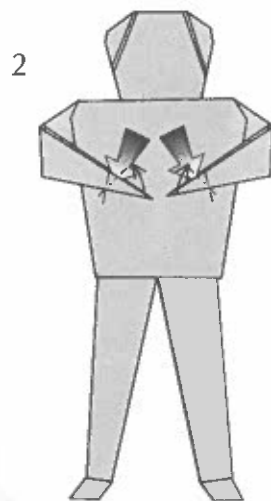

Squash folds.

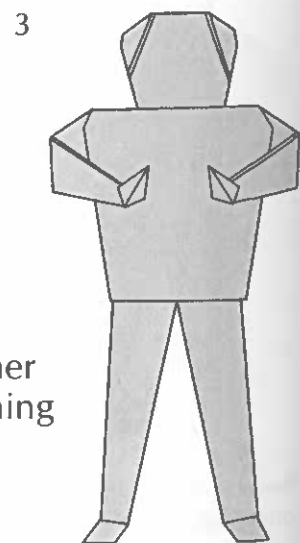

Drummer
 Drumming

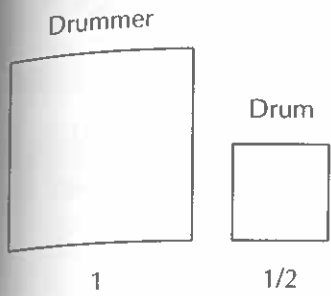

Drum

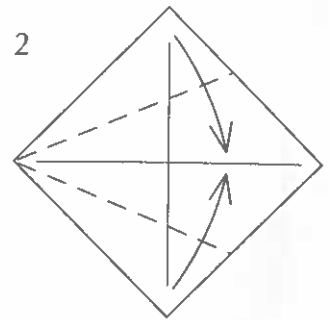
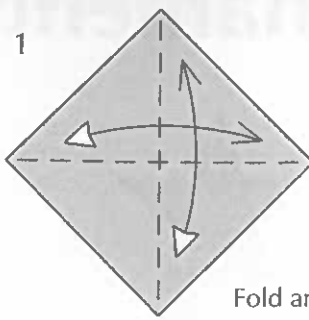

Fold and unfold.

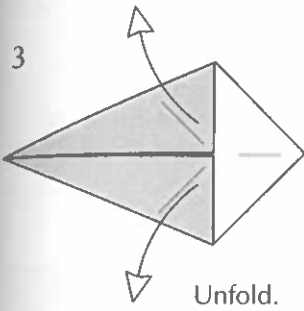

Unfold.

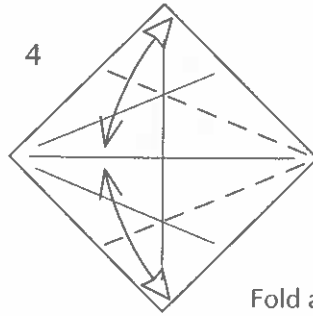

Fold and unfold.

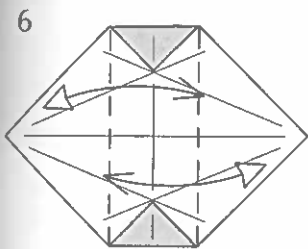
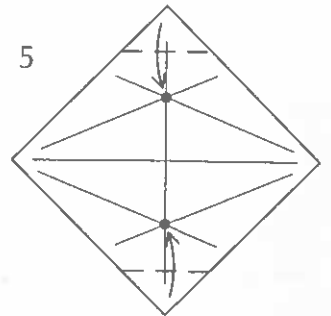

Fold and unfold.

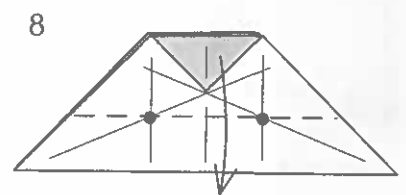
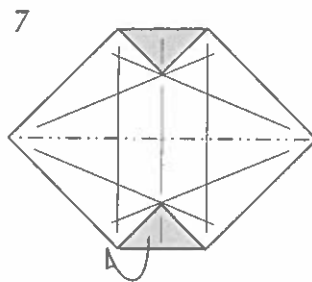

Repeat behind.

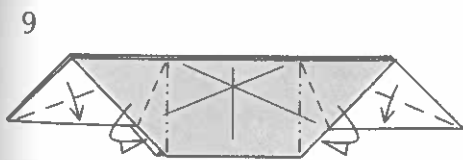

Repeat behind.

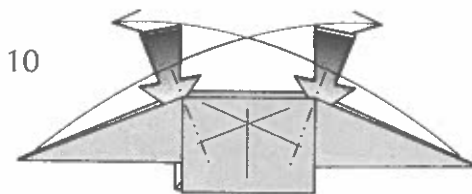

Reverse folds. The layers will overlap.

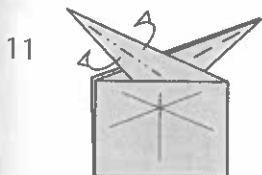

Fold all the layers together to form the sticks. Repeat behind.

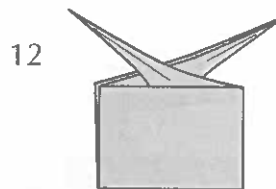

Drum

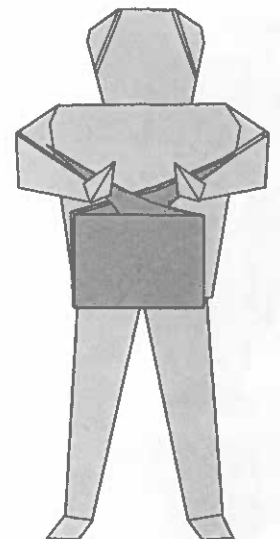

Drummer Drumming